



**OPERATING AND SERVICE MANUAL
MODEL: MAGNUM SPRAY INJECTION
PATCHER**

**PART MANUAL - 91285
Rev. "G"**



Revised: 05/04

**CRAFCO MAGNUM SPRAY INJECTION PATCHER
PART NUMBER 91000 - 250 GAL.
PART NUMBER 93000 - 350 GAL.**



TABLE OF CONTENTS

Crafcro Magnum Spray Injection Patcher.....	6
Safety Precautions.....	7-8
Limited Warranty.....	9
Warranty Claim Instructions.....	10
Cautions.....	11
 Operating Instructions	
Preparing for Operation.....	12
Start Up.....	13-15
Shut Down.....	16
Clean Out Instructions.....	17
 Maintenance	
Specifications.....	18
Lubricating and Maintenance Instructions.....	19
 Trouble Shooting	
Trouble Shooting.....	20-21
Material Specifications.....	22
Wiring Code for Tail Lights and Brakes.....	22
 Tensioning V-Belt Drives	
Instructions.....	23
Maintenance Guide of the V-Belt Drives.....	24
 Photos, Drawings and Parts	
Operator Boom, 45 Degree Elbow/Boom Nozzle.....	25
Rear Components of the Magnum	
Operator Boom, Aggregate Hose and Tail Lights.....	26
Operator Boom, Rear Control Console.....	27
Dual Hydraulic Control Valve.....	28
Rotary Air Blower - Components	29
Hydraulic Tank -Components.....	30
Hydraulic Pump Bolted to the John Deere Engine Compressor.....	31-32
Aggregate Feed System, Center Auger, Rear Hydraulic Motor.....	33
Aggregate Feed System, Airlock System - Below Frame - Photo 1.....	34
Aggregate Feed System, Airlock System - Inside Frame - Photo 2.....	35
Front View of Magnum - Engine Cover, Jack, Aggregate Hopper, Front Hitch Plate, Chains.....	36-37
6" Aggregate Screw Feed Pipe/Torflex Axles and Tires and Rims.....	38-39
Aggregate Hopper and 6" Aggregate Feed Screw Assembly.....	40
Front View of Magnum - Back-Up Alarm, Hopper Safety Switch.....	41
Aggregate Hopper Front Bearing.....	42
Rear Passenger Side View of Magnum-Diesel Flush Tank, Fuel Tank, Battery.....	43
Battery Box.....	44
Emulsion Tank, Crack Filling Attachment (Option).....	45
Crack Filling Attachment- Option.....	46
Diesel Storage Tank.....	47
Diesel Flush Tank/Fuel Tank.....	48
Strobe Light- Option.....	49
Emulsion Tank, Top Valve Assembly.....	50
Emulsion Tank Temperature Gauge.....	51
Front View of Emulsion Tank and Components.....	52
Rear Driver's Side Flush Out Box and Trough of Machine.....	53-54
Emulsion Tank Rear Valve Assembly.....	55
Control Console Panel.....	56

TABLE OF CONTENTS

Photos, Drawings and Parts

Engine and Engine Cover/Components.....	57
Drive Train System - Engine to Blower/Belt Drive.....	58-59
Hydraulic Tailgate and Components.....	60
Thermostat Box and Components.....	61
Diesel Flush Tank.....	62
View of Airlock System and Components Under Rear of Machine.....	63
View of Airlock System Rear and Components Rear of the Machine....	64
Engine Air Compressor and Compressor Governor.....	65
Water Pump Outlet Heating Valve.....	66
Hydraulic System.....	67
Water Pump Outlet Heating Valve.....	68
On-Board Compressor Check Valve Assembly.....	69
Return Water Heating Valve Assembly.....	70
John Deere Engine Components.....	71
Magnum Blower Air Cleaner.....	72
Magnum Blower Air Cleaner.....	73
Aluminum Hydraulic Circuit Manifold.....	74
Decal-Towing of The Spray Injection Patcher.....	75
Electric Throttle-Remot Control/Actuator.....	76
Operator Boom and Hose.....	77-78
Tail Light and License Bracket.....	79
John Deere Engine Control Panel.....	80-81
Arrow Board Controller Protection Box.....	82-83
Bolt-On Engine Compressor and Components.....	84
On-Board Compressor Valve Assembly.....	85
Emulsion Tank Gauge Holder.....	86
Emulsion Tank Gauge.....	87
Hydraulic Tailgate Assembly (91196k).....	88-93
2-1/2" I.D. Front Pintle Hitch.....	94
Rear Boom Saddle.....	95
Spring Arm Assembly.....	96
Control Console.....	97
Armored Clearance Light.....	98
Silencer.....	99
Blower Pressure Relief Valve.....	100
Water/Fuel Separator.....	101
8 Foot Quick Flush Hose-Option.....	102
Manual Box.....	103
Inlet Hood-Air Cleaner.....	104
3" Round red Reflector.....	105
Emulsion Tank Drain Valve Assembly.....	106
Magnum Cobra Boom Arm Assembly.....	107-109
Magnum Nozzle Discharge Assembly.....	110-111
Magnum Rear Passenger Side Components.....	112-113
Magnum Air Discharge Plumbing Circuit.....	114-115
Magnum Aggregate Boom Clamp Assembly.....	116-117
Magnum 6" Aggregate Screw Feed Assembly.....	118-119
Magnum-Engine to Blower Drive Belt System-3 Belt System	120-121
Magnum Emulsion Supply Line Routing.....	122
Magnum Air Line supply Line Routing.....	123
Magnum Hydraulic Schematic.....	124
Magnum Wiring Schematic.....	125
Magnum Engine Control Panel Sub-Assembly-80 h.p.....	126
Standard Dump Truck and Standard CrafcO Hydraulic Tailgate.....	127-129
Top Side Support, Bottom Side Support, Top board Installed.....	130
Hitch Extension.....	131

CRAFCO MAGNUM SPRAY INJECTION PATCHER

This manual is furnished with each new **CRAFCO MAGNUM SPRAY INJECTION PATCHER**. The manual will help your machine operators learn to run the machine properly and understand its mechanical functions for trouble-free operation.

Your **CRAFCO MAGNUM SPRAY INJECTION PATCHER** is designed to give excellent service and save maintenance expense. However, as with all specifically engineered equipment, you can get best results at minimum costs if:

- (1) You operate your machine as instructed in this manual, and
- (2) Maintain your machine regularly as stated in this manual.

SAFETY PRECAUTIONS

- All operators must be thoroughly trained.

- High operating temperatures of machine require protective clothing and gloves be worn by operator.



- Wear gloves while operating equipment.

- Always wear eye and ear protection.

- Always wear proper protective clothing.



- Observe all **CAUTION AND WARNING** signs posted on machine.

- Read Operator Manual thoroughly before operating machine.



- Make sure operator is familiar with machine operation.

- Do not operate in closed building or confined areas. (Example: due to exhaust fumes)

- Shut-down engine prior to refilling diesel tank.

- Keep hands, feet, and clothing away from all moving parts.

- Always keep a fire extinguisher near the unit. Maintain extinguisher properly and be familiar with its use.

- Calibrate temperature control prior to initial operation and each 50 hours of operation.

- Replace any hoses which show signs of wear, fraying, or splitting. Be sure all fittings and joints are tight and leak-proof.

- Precaution is the best insurance against accidents.



- The CrafcO Magnum should not be left unattended while running.

- Tighten all bolts and screws after every 100 hours of operation.

- CRAFTCO, Inc. assumes no liability for an accident or injury incurred through improper use of the machine.

- Check and maintain correct tire pressure, check tires weekly. Check axles weekly.

- Check machine thoroughly for any signs of improper wear.

SAFETY PRECAUTIONS continued

- Crafco, Inc. recommends that the purchasers or users of the merchandise or products frequently and consistently undertake inspections and protective measures with respect to the use and application of the product and merchandise.

- Do not disassemble any valve while under pressure.

- Hose assemblies to service should be inspected frequently for leakage, kinking, corrosion, abrasion or any other signs of wear damage.

- A good place to begin preventive maintenance is with a periodic drive inspection as a normal part of your maintenance rounds. Look and listen for any unusual vibration or sound while observing the guarded drive in operation. A well designed and maintained drive will operate smoothly and quietly.

> Caution: Do not fill the emulsion storage tank more than 2/3's full. The emulsion will expand after the emulsion is heated up. Starting at the bottom of the lid opening, fill the emulsion about 12" down from the bottom of the lid opening. If you over fill the emulsion storage tank, you can damage the slide gate, compressor, and other vital componets of the machine. If you over fill your emulsion storage tank you will void the warranty.

CRAFCO SPRAY INJECTION PATCHER LIMITED WARRANTY

Crafco, Inc., through its authorized distributor, will replace for the original purchaser free of charge any parts found upon examination by the factory at Mesa, Arizona, to be defective in material or workmanship. This warranty excludes engine or components, tires, and battery as these items are subject to warranties issued by their manufacturers.

Crafco, Inc., warrants for (2) years the machined venturi on Air Stream and Air Stream T-M models.

Crafco, Inc., warrants structural parts, blower and coupling, boom arm, emulsion heating system, and air-feed system, (excluding nozzle and rubber discharge hose and auger and housing tube on Magnum models) for a period of (1) one year from date of delivery. Excluded from this warranty are normal wear items i.e., hoses, belts, filters, and lubricants. Crafco, Inc., shall not be liable for parts that have been damaged by accident, alteration, abuse, improper lubrication/maintenance, normal wear, or other cause beyond our control.

The warranty provided herein extends only to the repair and/or replacement of those components on the equipment covered above and does not cover **labor** costs. The warranty does not extend to incidental or consequential damages incurred as a result of any defect covered by this warranty.

All transportation and labor costs incurred by the purchaser in submitting or repairing covered components must be borne by the purchaser.

Crafco, Inc. specifically disavows any other representation, warranty, or liability related to the condition or use of the product.



WARNING: Use of replacement parts other than genuine Crafco parts may impair the safety or reliability of your equipment and nullifies any warranty.

WARRANTY CLAIM INSTRUCTIONS

Please follow the instructions stated below when calling in a Warranty Claim. Failure to follow these procedures may be cause to void the warranty.

1. Call your local CrafcO distributor. If you do not know who your local distributor is, call a CrafcO Customer Service Representative, (Toll Free 1-800-528-8242) for name, location, and telephone number.
2. On contacting the dealer, be prepared to identify the machine type, model number, and serial number, also, the date of purchase if available.
3. Should the cause of the malfunction be a defective part, the distributor will advise you of the procedure to follow for a replacement.
4. The warranty is valid only for parts, which have been supplied or recommended by CrafcO, Inc.

If you have any additional questions regarding warranty repairs and parts, please do not hesitate to call toll free 1-800-528-8242.

CrafcO, Inc.
Corporate Office
420 N. Roosevelt Ave.
Chandler, AZ 85226
Toll Free 1-800-528-8242
602-276-0406

CrafcO, Inc.
Mesa Equipment Plant
235 S. Hibbert
Mesa, AZ 85210
480-655-8333

CAUTIONS

1. NEVER OPERATE MACHINE WITHOUT ALL GUARDS IN PLACE.
2. DO NOT OPEN HATCH LID ON EMULSION TANK (90640). DO NOT OPEN DIESEL FLUSH TANK FILL PORT (90860). DO NOT OPEN EITHER TANK UNDER PRESSURE. DO NOT OPEN EMULSION TANK REAR VALVE ASSEMBLY (90628). TO RELIEVE PRESSURE, USE THE EMULSION TANK TOP VALVE ASSEMBLY (90629). OPEN BRONZE BALL VALVE - 1/2" (29214). TO RELIEVE PRESSURE ON DIESEL FLUSH TANK OPEN 2" BRASS BALL VALVE (29281). GAUGE (29961) SHOULD READ "0".
3. Do not plug in emulsion tank heater (91799) unless emulsion is above the heating element enclosure inside the tank. This requires a minimum of 60 gallons in the tank.
4. Keep emulsion tank airtight when not in use.
5. Do not allow emulsion to freeze. (Store in dry area.)
6. Do not put hands, feet, etc. near truck auger tailgate (91196).
7. Do not fill flush tank (90860) more than 2/3 full.
8. Do not point the nozzle (91100) at another person.
9. Do not operate near an open flame.
10. Do not use any type of flame to unclog the emulsion hose or spray ring if they should become clogged.
11. When applying material out the nozzle (91100), protective eye glasses and protective clothing should be worn.
12. Do not operate diesel engine above 2200 RPM MAX.
13. Do not touch the silencer as it can become very hot while the CRAFCO MAGNUM is operating.
14. Hose should not be kinked or run over by any equipment. Hose should not be stored outdoors due to potential damage from the elements, which may shorten hose life.
15. Hydraulic hose assemblies that are worn or damaged should be removed from service and replaced immediately.

CRAFCO MAGNUM SPRAY INJECTION PATCHER OPERATING PROCEDURES

PREPARING FOR OPERATION

Emulsion - The emulsion tank should be filled with an asphalt emulsion suitable for the climate and condition in which the unit will be operating. Commonly this is an RS 2 or a CRS 2.

(Note: All emulsions are not compatible. When changing emulsion brand or type, you should completely empty and flush out the tank before the new emulsion is added.)

Proper operation temperature for the emulsion is 160°F (+/- 10°F). If the emulsion is below this temperature the unit must be plugged into a 110 volt outlet. *(Optional 220 Volt wiring is available)* The thermostat should be set at 160°F. The electric heating elements are designed to gently heat the emulsion at a rate of 10°F per hour. If the emulsion temperature is low it will take several hours to get the emulsion to operation temperature. Plugging the unit in overnight is recommended.

(Never allow emulsion to freeze or heat emulsion above 190°F.)

Stone - A 3/8" crushed washed aggregate is the most common and versatile stone to use in patching operations. Smaller stone (1/4") can be used and may improve results when skin patching. Larger stone (1/2") can be used to improve results when patching larger holes or repairing shoulders.

Solvent - Fill the solvent tank with diesel fuel or another solvent that has been recommended by the emulsion supplier.

Each day, before operating the unit, raise the dump body on the truck and rinse the stone with water. Allow the water to drain for several minutes. This will greatly reduce the dust developed during the patching operation and will improve the adhesion of the emulsion to the stone.

CRAFCO MAGNUM SPRAY INJECTION PATCHER OPERATING PROCEDURES

START UP

1. Pressurize the emulsion tank.

- a. Remove the boom from the holder and remove the nozzle from the **Flush Box**.
- b. With the nozzle pointed at the ground, start the engine and allow to run for several minutes. The compressor runs when the engine is running and will automatically start building pressure in the emulsion tank. Allow the pressure to build until the pressure reaches a minimum of 90 PSI.

2. Charge the auger with stone.

- a. Set the auger flow control at 4 and the tailgate control at 3.
- b. With the engine running at an idle, turn ON the "STONE" switch at the operator control panel.
- c. Stone will quickly start to shoot out of the nozzle. Run the unit for 45 to 90 seconds until stone is flowing smoothly with no surging then shut OFF the "STONE" switch.
- d. Shut off the engine, place the boom back in the transport support, and place the nozzle in the "FLUSH BOX".

3. Set the auger feed for operation.

- a. **SKIN PATCHING** - Auger at 3 - Tailgate at 1.
- b. **POT HOLE PATCHING** - Auger at 4 - Tailgate at 2.
- c. **SHOULDER REPAIRS** - Auger at 8 - Tailgate at 4.

These settings may be adjusted to meet the operators comfort level. As you make adjustments you should always keep the flow of material into the hopper above the top of the auger. About half full in the hopper is correct. Overfilling the hopper can jam the auger.

4. Purge the solvent from the emulsion lines.

- a. Locate the EMULSION TANK VALVE at the rear of the emulsion tank.

CRAFCO MAGNUM SPRAY INJECTION PATCHER OPERATING PROCEDURES

START UP

- b. With the nozzle positioned in the flush box and the engine off, turn the EMULSION TANK VALVE to the position marked Emulsion Only.
- c. Slowly open the EMULSION VALVE at the OPERATOR CONTROL PANEL approximately 1/4 open. Solvent will begin to flow from the nozzle. This will take 10 to 15 seconds.
- d. When the solvent is purged and emulsion is visible at the nozzle, quickly close the EMULSION VALVE.

5. Patching

- a. Remove the boom from the transport supports and position the nozzle over the area to be repaired.
- b. Start the engine.
- c. Adjust the throttle up to 2000 RPM.
- d. Lower the nozzle to about 12" from the ground and blow all dust, dirt and standing water away for the repair area.
- e. Reduce the engine RPMs to:
 - Skin Patching - 900 to 1000 RPM
 - Holes - 1100 to 1200 RPM
 - Shoulder Repairs 1300 to 1500 RPM

(With variables in stone, equipment and operator you may find that your unit works better at slightly higher RPM. These settings are our recommended settings for 3/8" stone. Each operator can adjust to their comfort level. We suggest with 1/2" stone increase by 100 RPM and with 1/4" stone decrease slightly.)
- f. Raise the nozzle to 24" to 30" from the pavement (*Knee High*) and slowly open the EMULSION VALVE approximately 1/4 open.
- g. Tack the repair area with emulsion. *(Coating the entire area including 6" past the edge of the repair is best. Highly distressed areas and damp areas require heavier tack application for good long lasting repairs.)*

CRAFCO MAGNUM SPRAY INJECTION PATCHER OPERATING PROCEDURES

START UP

- h. With the emulsion running, turn on the STONE SWITCH. Stone will immediately start shooting from the nozzle. *(If stone surges you may need to increase the engine RPM of the stone feed to the auger & tailgate.)*
- i. Continuously move the nozzle over the repair, building your repair from the bottom up. *(If you hold the nozzle still, material will build up and you will not achieve a smooth repair.)*
- j. As the stone builds on the pavement you should see that less than 10% of the stone looks uncoated when your stone and emulsion flow are adjusted properly. If an excess of emulsion appears reduce the emulsion flow. If the stone appears undercoated increase the emulsion flow. *(Emulsion is the glue. To get a long-lasting repair, make sure you have enough emulsion.)*
- k. When the repair is at the desired level, close the EMULSION VALVE. Dry stone will continue to flow from the nozzle. Lightly cover the entire repair with dry stone to complete the repair.
- l. Shut off STONE SWITCH. *(Stone continues to flow for about 10 seconds after the switch is off.)*
- m. Move the nozzle away from the repair area.
- n. Lower the engine RPM.

(TIP: With a push broom clean up any overspray of material by sweeping it back onto the repair area.)

- 6. **Move to the next repair area.**
(Never travel without properly stowing boom in the transport supports and locking into position. NEVER place the nozzle in the flush box with the engine running.)

CRAFCO MAGNUM SPRAY INJECTION PATCHER OPERATING PROCEDURES

SHUT DOWN

1. Shut down the engine
2. Stow boom in transport supports and place the nozzle in the FLUSH BOX.
3. Turn the FLUSH VALVE to Flush Only.
4. Open the EMULSION VALVE and allow emulsion to flow into the FLUSH BOX until solvent replaces the emulsion coming out of the nozzle.
5. Shut EMULSION VALVE.
6. Turn the FLUSH VALVE to Off.
7. Set the tailgate control to 0 and the Auger control to 4.
8. Remove the nozzle from the flush box.
9. Start the engine and set the RPM at 1200.
10. Turn on the rock switch.
11. Rock will flow from the nozzle. Allow rock to flow until most of the rock is purged from the auger and the hopper, 2 to 3 minutes.
12. Shut off the rock switch.
13. Shut down the engine.
14. Stow the boom and the nozzle and lock in position for transport.

Stone can also be purged by opening the gate below the hopper, reversing the hydraulic line for the auger and feeding the stone back towards the trailer tong. This method allows you to capture the stone in pails rather than depositing on the roadside.

CRAFCO MAGNUM SPRAY INJECTION PATCHER OPERATING PROCEDURES

CLEAN OUT INSTRUCTIONS

ASPHALT EMULSION LINE

The emulsion line (29596) should be flushed preferably with a non-flammable citrus based asphalt solvent or diesel fuel, when the time between repairs exceeds 20 minutes, and at the end of every day. To flush the line: Turn valve (90628) to flush and open valve (91700). Flush into flush box (91200). Flush only when engine is turned off. If the emulsion line ever becomes clogged do not attempt to unclog by applying any type of open flame to the emulsion line. No open flame should be used to clean any part of the Magnum equipment.

If some asphalt emulsion is spilled on the machine it can be wiped off immediately with diesel fuel or asphalt solvent.

If asphalt emulsion has accumulated on the machine or hoses you should spray them with your asphalt cleaner, let soak approximately 3 minutes and wash off with water or steam. This should be done weekly.

AGGREGATE FEED SYSTEM

The aggregate hopper (91130) should be cleaned of fines by dropping the trap door on the bottom of the hopper daily. The entire aggregate feed assembly should be rinsed with water for 10 minutes daily with the engine operating at 1,500 RPM and the center screw (91054) turning at approximately 35 RPM and the truck auger (91196) off. This will thoroughly clean the unit of any fines and assure smooth operation to maintain the Magnum high output.

AIR CLEANERS (BLOWER AND ENGINE)

1. Replace the filter only when the restriction level has reached the maximum recommended by the engine or equipment manufacturer (91045).
2. Empty dust cap. Dust cap should be dumped when 1/3 full. When reinstalling dust cap, be sure it seals 360° around the air cleaner body. Check the vacuator valve to see that it is not inverted, damaged or plugged. If it is damaged, replace it immediately (91727).

CRAFCO MAGNUM SPRAY INJECTION PATCHER

SPECIFICATIONS

Motor (John Deere).....	Maximum 2200 R.P.M.
Air Pump (Blower).....	2475-2887 R.P.M.
Air Pump (Blower).....	Positive Displacement
Hydraulic Pump.....	Maximum 2200 R.P.M.
Hydraulic Fluid.....	22 Gallon Capacity
Diesel Flush Tank.....	30 Gallon Capacity
Diesel Fuel Tank.....	22 Gallon Capacity
Emulsion Tank.....	250 Gallon Capacity
Emulsion Temperature.....	160°F. - 175°F.
Operating Temperature Range.....	Above 0°F.
Hydraulic Pressure (with load).....	600-1000 P.S.I.
Center Screw.....	39 +/- 10 R.P.M.
Truck Auger.....	31 +/- 6 R.P.M.

LUBRICATING AND MAINTENANCE INSTRUCTIONS

1. Engine - refer to separate manual in packet (John Deere Maintenance Manual). The manual is located in the manual box on the passenger side engine cover.
2. Blower - refer to separate manual in packet (Tuthill Blower Manual). The manual is located in the manual box on the passenger side engine cover.
3. Compressor - check separate manual in packet (John Deere Maintenance Manual). The manual is located in the manual box on the passenger side engine cover.
4. Lubricate bearings at each end of screw conveyor on truck approximately every 75 hours. Lubricate bearing on center auger under the aggregate hopper. See page 79 (Item Number 9.)
5. Check hydraulic oil level every day.
6. Check and tighten all bolts periodically, including axles (approximately 100 hours).
7. Remove and clean hydraulic oil filter in first 30 hours and then every 100 hours. Replace return line filter the first 30 hours then every 100 hours.
8. Lubricate bearings every 100 hours for boom. Boom has two bearings, an upper and a lower. Grease lightly.
9. Grease the bearing stub support shaft assembly on the back of the bell housing.
10. Axle-refer to separate manual in the packet (Dexter Axle Maintenance Manual). The manual is located in the manual box on the passenger side of the engine cover.

TROUBLE SHOOTING

IF NO EMULSION IS PRESENT

CHECK THE FOLLOWING:

1. Is the emulsion tank empty? To find out, remove tank pressure first, then open the pressurized lid on emulsion tank.
2. Is the emulsion line valve closed? To find out, the line is located at the rear of the machine on the tank.
3. Is the PSI low in the emulsion tank? Check the PSI gauge located in the middle of the emulsion tank.
4. Is the nozzle spray ring plugged? Remove the nozzle and clean.
5. Is the hose from the emulsion tank to the nozzle plugged? If equipped with a heated hose, start engine to allow heating, and turn the diesel flush on. Do not attempt to unplug the emulsion hose by applying an open flame to the emulsion hose or spray ring. The system is equipped with a heating system (standard). Start the engine and let it run to heat the emulsion hose.
6. Is the emulsion cold? Check the emulsion temperature gauge on the emulsion tank. Check to be sure the thermostat and the heating element are working.
7. Has the emulsion separated and become lumpy? Check the emulsion by placing a rod to the bottom to check for "bubble-gum-like" asphalt residue on the bottom. If the emulsion is separated, drain the tank and flush with the diesel fuel.

HYDRAULIC SYSTEM MALFUNCTION (OPTIONAL)

CHECK THE FOLLOWING:

1. Check the oil in the hydraulic reservoir located on the driver's side of the machine.
2. Check the hydraulic pump bolted to air compressor on John Deere engine. If needed, crack the hydraulic hose slightly to see if the fluid is pumping.
3. Check the stone switch for loose wires.
4. Check the solenoid for all loose wires. (To check, hold hand on solenoid and energize switch, you should be able to feel the impulse in the valve.)
5. Check for hydraulic system overload (PSI over 2,000 on hydraulic gauge) located in engine control panel.
 - A. Check the augers in the tailgate. If too much stone is piled on top of the augers the weight of the stone may cause the augers to stop turning or if dirty wet stone sits in the augers overnight, it may harden thereby preventing the augers from

turning. If either of these conditions exist, be sure to turn off the engine, then remove stone from the top of the augers (top of the auger should be visible) and loosen any packing or buildup under the augers.

- B. Check the tailgate feeder aggregate shoot. If stone is not free falling it will wedge at the top and create undue strain on the hydraulic system. Turn off the AIR STREAM engine, raise the dump bed, lower shoot, or remove the obstruction from the shoot as required. Lower truck bed to appropriate height. Lower shoot and increase angle of shoot in aggregate hopper so stone cannot "sit" on the shoot.

MOTOR WILL NOT START

CHECK THE FOLLOWING:

Refer to the John Deere Engine Manual located in the manual box on the back of the engine cover.

AGGREGATE NOT COMING THROUGH HOSE

CHECK THE FOLLOWING:

1. Is the aggregate hopper empty?
2. Is the aggregate stone flowing down the dump body into the tailgate feeder hose? Check the gravity feed tailgate.
3. Check the hydraulic system.
4. Check the engine R.P.M. - 2,200 MAX.
5. Is the aggregate hose plugged? Angle front section of hose and nozzle down and shake hose. If hose is still plugged, remove the hose from the air flow pipe, angle down and shake hose, then reattach hose to air flow pipe. If hose is still plugged, flush out with large amounts of water as described in Aggregate Feed System (page 17).
6. Is the nozzle plugged? Remove the nozzle and clean.
7. Check the 6" airlock to see if the aggregate has become plugged with aggregate.
8. Check the aggregate hose at the airlock to see if the aggregate is wedged.

CRAFCO MAGNUM SPRAY INJECTION PATCHER

MATERIAL SPECIFICATIONS

Below are general specifications for the materials used in Magnum. The materials are very common. This is not a complete list, as a variety of materials can be used and manufacturer trade names vary by locality. Please call if we can assist in anyway.

STONE

General description: 3/8" or 1/4" preferably washed angular crushed stone. Round river rock also acceptable, crushed preferred.

GENERAL SIEVE ANALYSIS

100%	1/2 inch
90 - 100%	3/8 inch
20 - 100%	3/16 inch (#4 screen)
5 - 30%	1/8 inch (#8 screen)
0 - 10%	1/16 inch (#16 screen)

EMULSION

General description: Rapid setting asphalt emulsion, commonly referred to as RSII, CRSII and sometimes CMSII. Other trade names are used in some areas. Rapid setting high floats are also acceptable, and are preferable in cold weather (less than 32°F.) operation.

SPECIFICATIONS

	Min.	Max.
Viscosity, Saybolt Furol @ 122 degrees F. (50°C.), s.....	75	400
Settlement, 5-Day, %.....		5
Storage Stability, Test, 24-h, %.....		1
Demulsibility, 35 ml, 60.....	40	
Sieve test, %.....		0.10
Residue by distillation, %.....	63	
Penetration, 77°F. (25°C.).....	100	
Ductility, 77°F. (25°C.), 5.....	40	
Solubility in trichloroethylene, %.....	97.5	

WIRING CODE FOR TAIL LIGHTS AND BRAKES

GD (Ground) - Black
LT (Left Turn) - Red
RT (Right Turn) - Green
S (Brakes) - White
TM (Running Lights) - Brown

CRAFCO MAGNUM SPRAY INJECTION PATCHER

TENSIONING V-BELT DRIVES

INSTRUCTIONS

GENERAL RULES OF TENSIONING

Ideal tension is the lowest tension at which the belt will not slip under peak load conditions.

Check tension frequently during the first 24 - 48 hours of operation.

Over tensioning shortens belt and bearing life.

Keep belts free from foreign material which may cause slip.

Make V-drive inspection on a periodic basis. Tension when slipping.

Never apply belt dressing as this will damage the belt and cause early failure.

SPECIFIC RULES FOR TENSIONING

To check for proper belt tightness you must measure the force required to achieve the desired deflection at the center of the belt span, midway between the two pulleys. Below are the minimum and maximum forces permissible to achieve the desired deflection. This should be checked after the first 24 hours, 48 hours and weekly thereafter.

Belt	Drive	Desired Deflection	Force to Achieve Deflection - Min.	Force to Achieve Deflection - Max.
91331	Blower	.156"	7.1#	10.5#

MAINTENANCE GUIDE OF THE V-BELT DRIVES

TYPE OF MAINTENANCE	WHEN TO DO	WHAT TO DO
Check for sheave groove wear.	Initial inspection - 8 hours. Second inspection - 24 hours. Third inspection - 100 hours. Periodically thereafter.	Check for belt riding in the groove. In multiple groove drives, belt ride should be uniform, not more than 1/16" above or below top of sheave groove. Check groove wear area for wear. Side wall of groove should be straight, not dishd out. Bottom of groove should show no signs of belt contact.
Check for sheave runout.	Initial inspection - 8 hours. Second inspection - 24 hours. Third inspection - 100 hours. Periodically thereafter.	Check sheave by eye for runout. If runout is excessive, it can easily be seen by visual inspection. If runout is noticeable, check sheave for source of problem and correct.
Inspect for heat build-up and proper ventilation.	Initial inspection - 8 hours. Second inspection - 24 hours. Third inspection - 100 hours. Periodically thereafter.	Check belts for heat. Ambient temperatures should not exceed 140°F. Contact temperatures should not exceed 180 °F. Make sure drives are properly ventilated.
Clean belts and sheave grooves.	Initial inspection - 8 hours. Second inspection - 24 hours. Third inspection - 100 hours. Periodically thereafter.	Inspect belts for contaminates, such as oil or grease. Wipe belts clean with detergent and water. Inspect sheave grooves for buildup of such material and remove, if necessary.
Check belt tension.	Initial inspection - 8 hours. Second inspection - 24 hours. Third inspection - 100 hours. Periodically thereafter.	Check belt tension using Browning belt tension checker. Tension to recommendations shown in current catalogs.
Check sheave alignment.	Initial inspection - 8 hours. Second inspection - 24 hours. Third inspection - 100 hours. Periodically thereafter.	Check alignment with straight edge, string or machinist level. Correct alignment to as near perfect as possible.
Mismatched belt check.	Initial inspection - 8 hours. Second inspection - 24 hours. Third inspection - 100 hours. Periodically thereafter.	Check belt sag on slack side of drive. All belts should have a slight bow. If this bow is not uniform with all belts, replace entire set with a matched set.
Check for worn belts.	Initial inspection - 8 hours. Second inspection - 24 hours. Third inspection - 100 hours. Periodically thereafter.	Check wear surfaces of belt for excessive wear. If belts have a slick, glazed look, belts are slipping. Check drive capacity and belt tension. Never replace only one belt in a used set, as used belts will elongate. Replace entire set if replacement is necessary.
Check sheave setscrews and/or bushing capscrews.	Initial inspection - 8 hours. Second inspection - 24 hours. Third inspection - 100 hours. Periodically thereafter.	Check all setscrews and/or capscrews for looseness. Retighten to recommended torque, if necessary.

OPERATOR BOOM, 45 DEGREE ELBOW/BOOM NOZZLE



NUMBER	PART NUMBER	QTY	DESCRIPTION
1	25951	1	3" U-BOLT MUFFLER CLAMP
2	91220	1	3" BOXED 45° ELBOW
3	91055	1	3" AGGREGATE PIPE & TRIANGLE HANDLE
4	91155	1	HOSE 3" X 24" GUM RUBBER LINED
5	91103	1	3" ALUMINUM NOZZLE HOUSING
6	91162	1	NOZZLE POSITION HANDLE
7	91100	1	NOZZLE WITH SPRAY RING ATTACHED
8	90303	1	EMULSION LINE COVER 6' - 3" - MAGNUM
9	91099	1	3" O-RING
10	90301	1	EMULSION WATER RETURN BUTTON "U"

REAR COMPONENTS OF THE MAGNUM OPERATOR BOOM, AGGREGATE HOSE AND TAIL LIGHTS



NUMBER	PART NUMBER	QTY	DESCRIPTION
1	90548	1	TAIL LIGHT WITH DOUBLE BULB
2	91032	1	ENGINE PANEL ASSY WITH ENGINE
3	91700	1	EMULSION REGULATION VALVE ASSEMBLY
4	91158	1	AGGREGATE HOSE 3" X 17'
5	91755	1	4-1/2" ID AGGREGATE PIPE HANGER
6	91162	1	NOZZLE POSITION HANDLE
7	29596	19 ft.	EMULSION HOSE - LINE
8	91761	1	SMALL CYCLOPS TAIL LIGHT

OPERATOR BOOM, REAR CONTROL CONSOLE

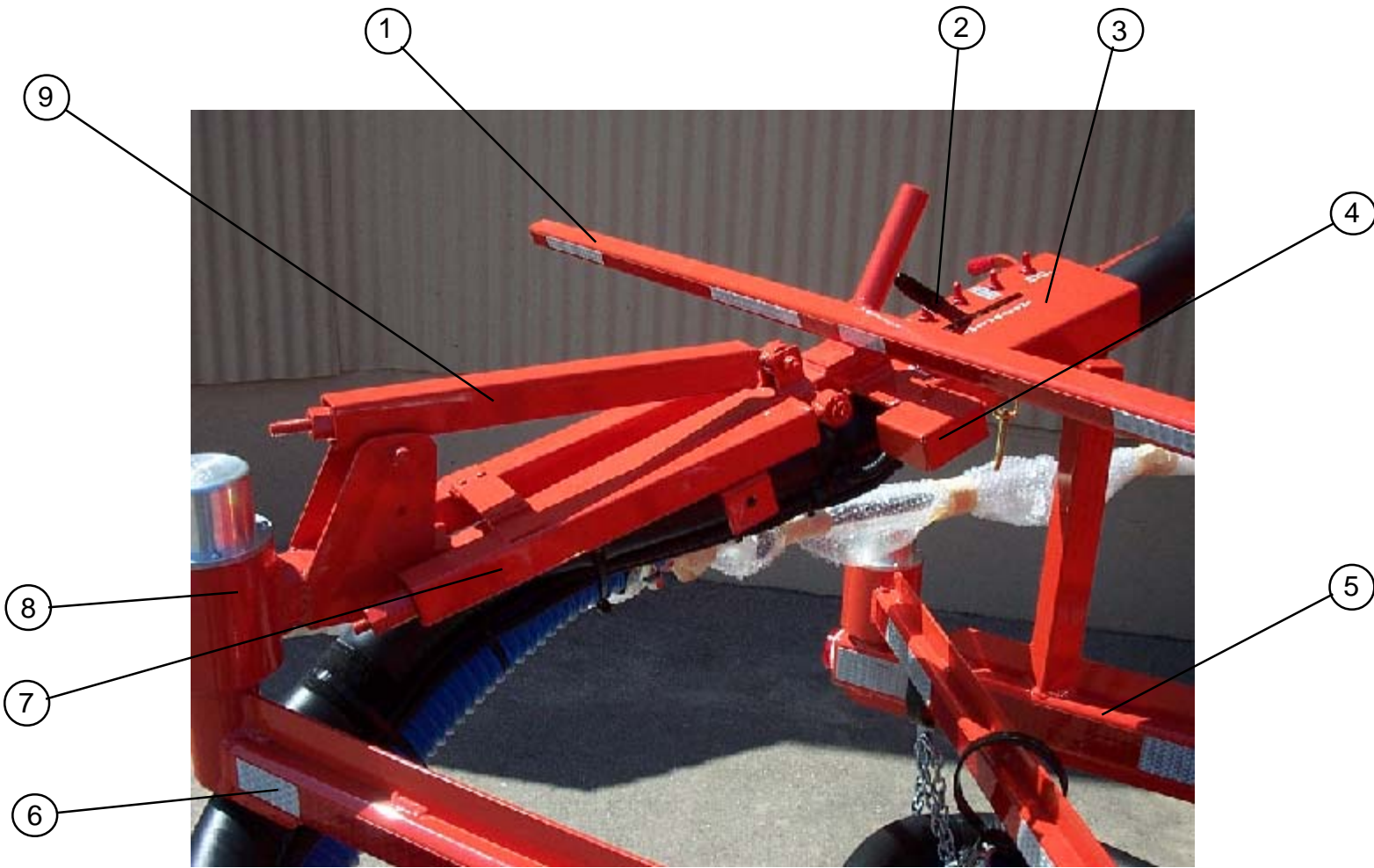

NUMBER	PART NUMBER	QTY	DESCRIPTION
1	91396	1	HANDLE ASSEMBLY
2	91700	1	EMULSION REGULATION VALVE ASSEMBLY
3	91230	1	COMPLETE ASSEMBLY CONTROL CONSOLE
4	91046	1	THROTTLE CABLE
5	91310	1	BOOM MOUNT SECTION/FRAME-MAGNUM
6	91545	1	BOOM SECTION 2ND COMPLETE
7	91170	1	SPRING CYLINDER COMPLETE
8	91320	1	BEARG/RACE WELD BUSHING PIVOT ARM
9	91169	1	UPPER SPRING CYLINDER COMPLETE

DUAL HYDRAULIC CONTROL VALVE

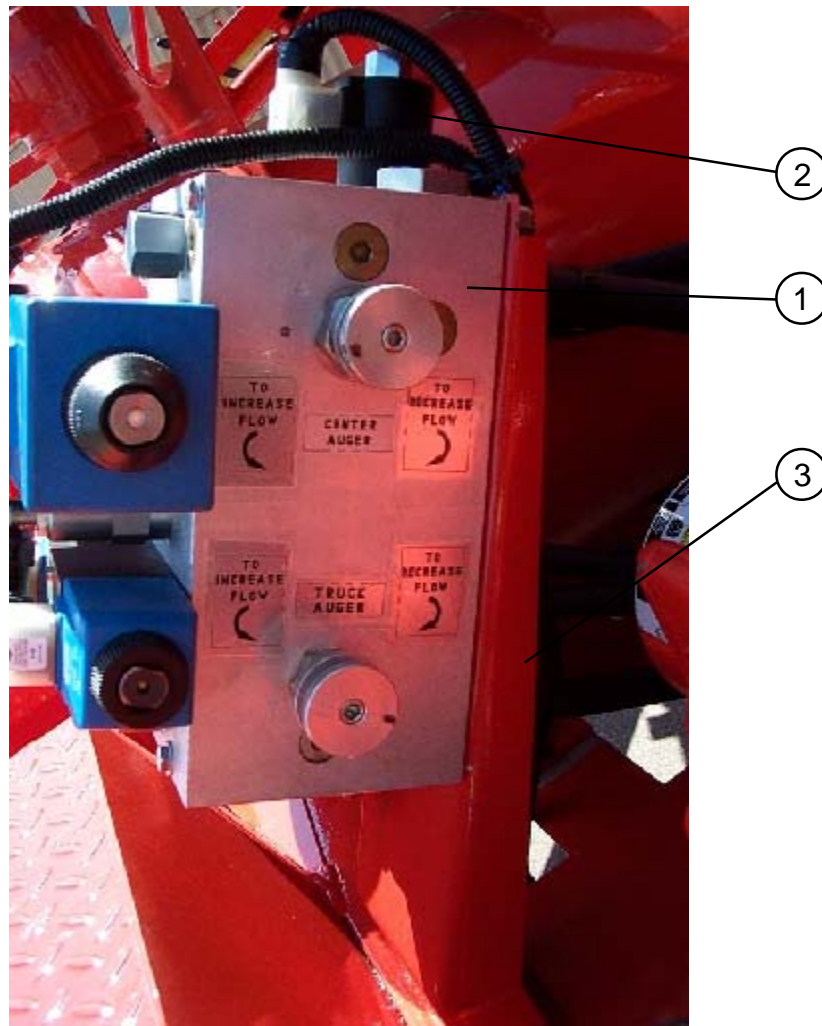

NUMBER	PART NUMBER	QTY	DESCRIPTION
1	92350	1	HYDRAULIC CONTROL VALVE ASSEMBLY
2	43474	1	DIN PLUG
3	91336	1	HYDRAULIC CONTROL VALVE MOUNTING PLATE

ROTARY AIR BLOWER - COMPONENTS

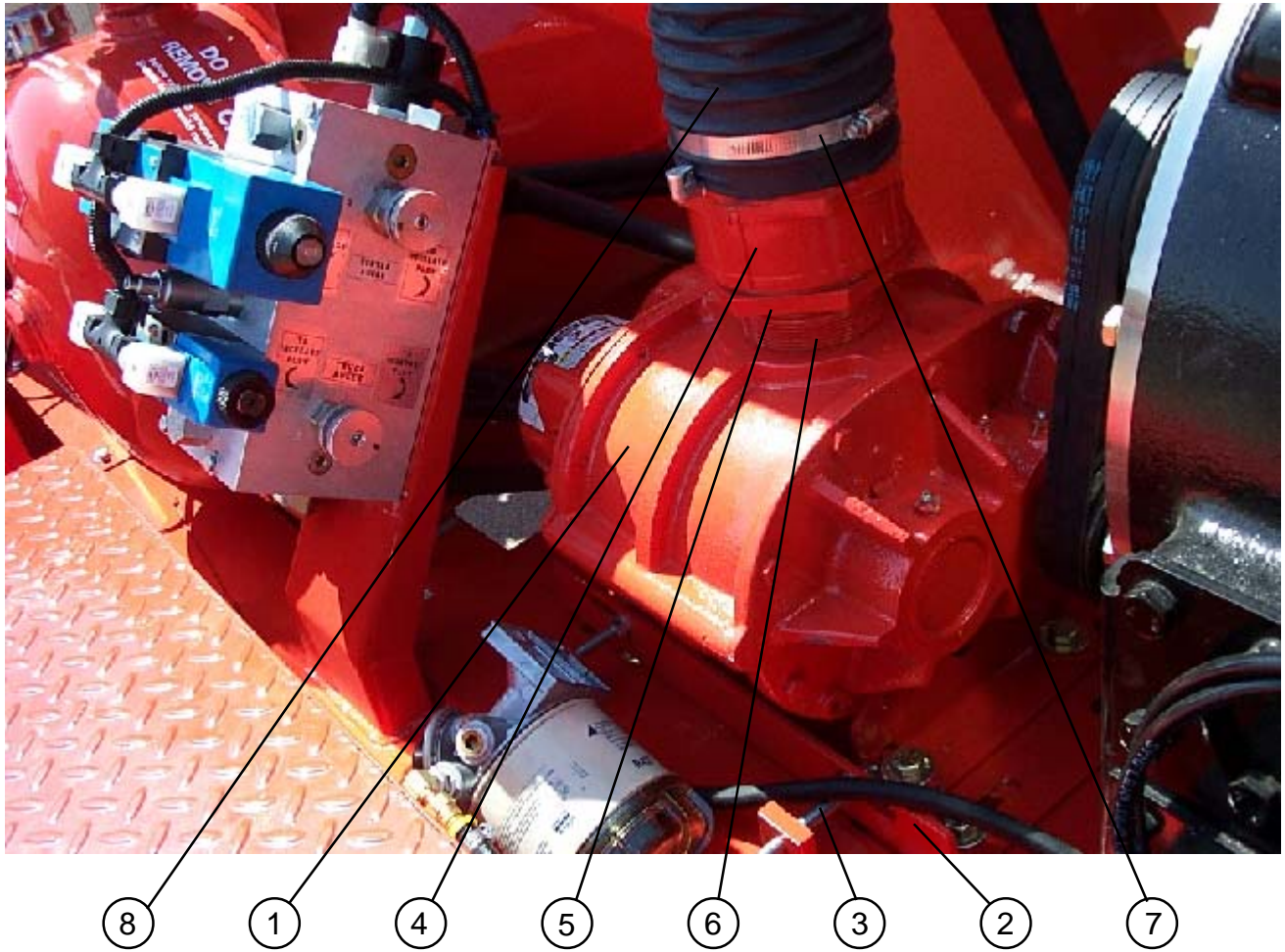

NUMBER	PART NUMBER	QTY	DESCRIPTION
1	60151	1	BLOWER
2	91330	1	BLOWER SLIDE PLATE
3	90858	1	3/8" - 16 X 4" ALL THREAD BOLT
4	90520	1	6" X 5" BLOWER/AIR CLEANER ADAPTOR
5	28364	1	4" X 3" REDUCER BUSHING
6	28010	1	3" CLOSED NIPPLE
7	91843	1	6" WORN - DRIVE HOSE CLAMP
8	91235	1	RUBBER CONNECTION HOSE TO BLOWER

HYDRAULIC TANK - COMPONENTS



NUMBER	PART NUMBER	QTY	DESCRIPTION
1	90570	1	HYDRAULIC CAP
2	90815	1	HYDRAULIC TANK - COMPLETE ASSEMBLY
3	90564	1	2" ROUND HYDRAULIC LEVEL SIGHT GAUGE
4	91306	1	MAGNUM BELT GUARD ENGINE BLOWER
5	43872	1	HYDRAULIC OIL FILTER ASSEMBLY
6	43871	1	HYDRAULIC OIL FILTER ELEMENT

**HYDRAULIC PUMP BOLTED TO THE
JOHN DEERE ENGINE COMPRESSOR**



NUMBER	PART NUMBER	QTY	DESCRIPTION
1	90800	1	HYDRAULIC PUMP JOHN DEERE ENGINE WITH COMPRESSOR

HYDRAULIC PUMP BOLTED TO THE JOHN DEERE ENGINE COMPRESSOR

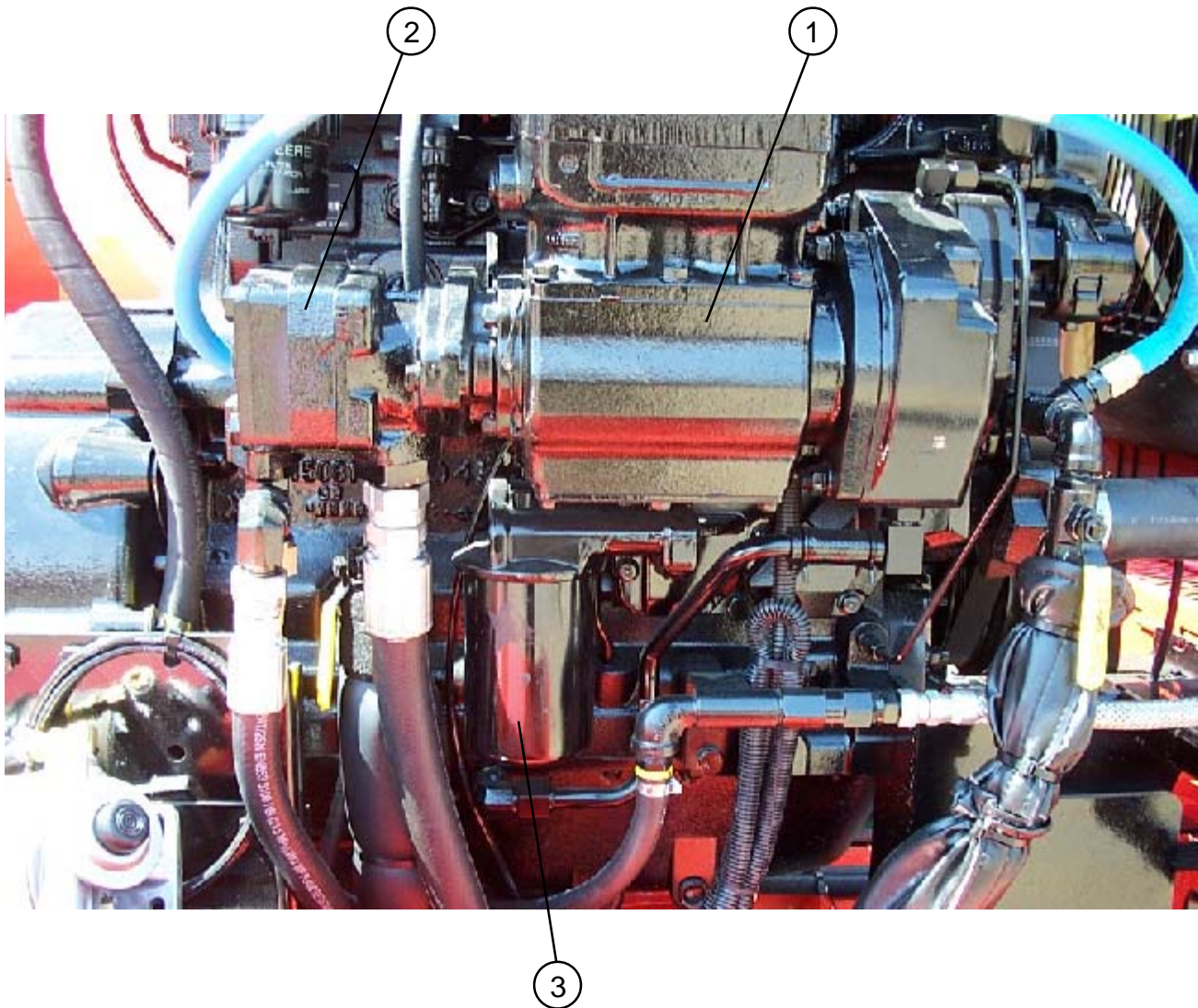

NUMBER	PART NUMBER	QTY	DESCRIPTION
1	91022	1	ENGINE BOLT ON 13 CFM COMPRESSOR - JOHN DEERE ENGINE
2	90800	1	HYDRAULIC PUMP JOHN DEERE ENGINE WITH COMPRESSOR
3	91044	1	ENGINE OIL FILTER

AGGREGATE FEED SYSTEM, CENTER AUGER, REAR HYDRAULIC MOTOR

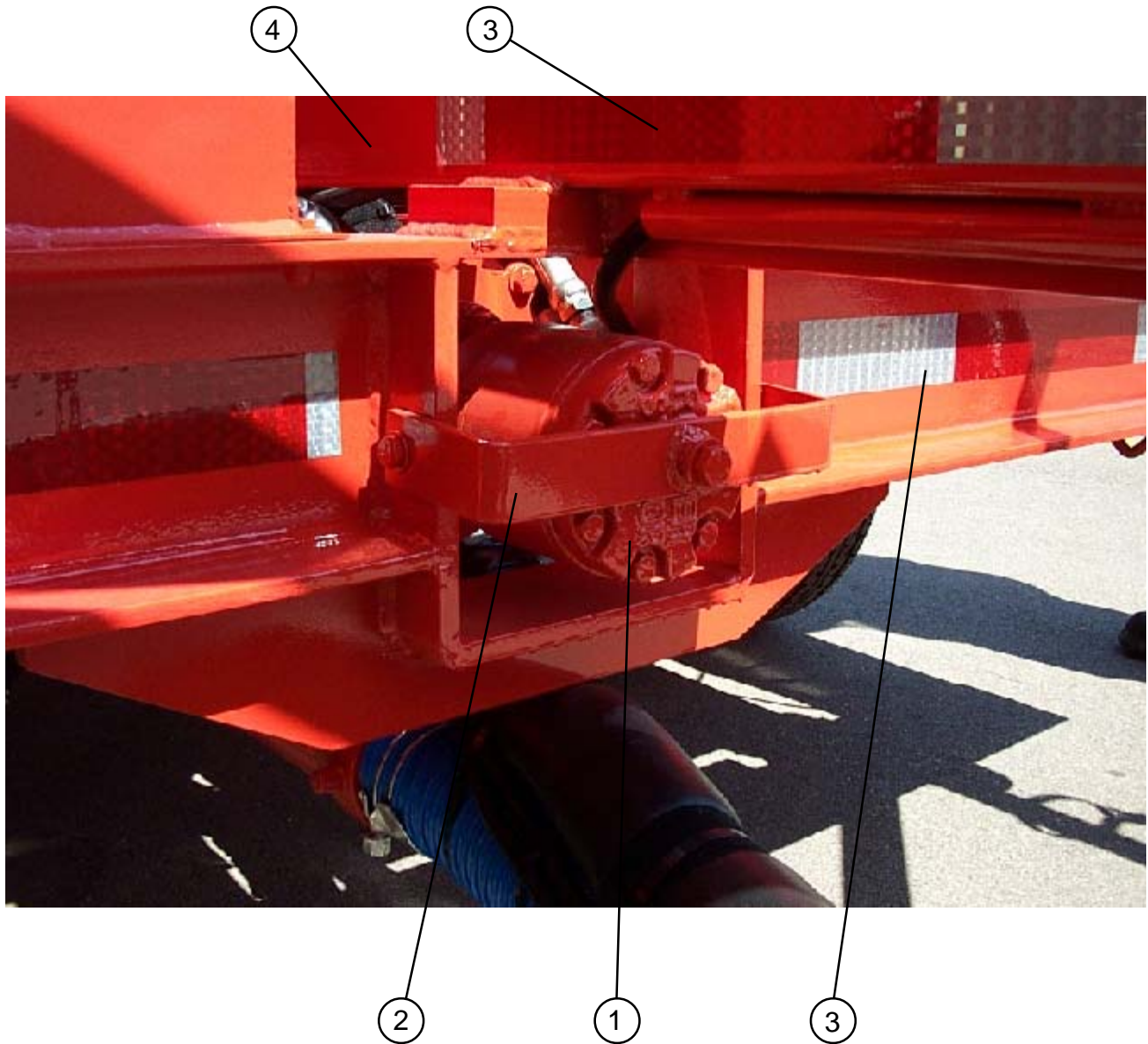

NUMBER	PART NUMBER	QTY	DESCRIPTION
1	91122	1	HYDRAULIC MOTOR
2	91106	1	HYDRAULIC MOTOR KEEPING BRACKET
3	90539	1	2" REFLECTIVE TAPE
4	91310	1	BOOM MOUNTING SECTION

**AGGREGATE FEED SYSTEM,
AIRLOCK SYSTEM - BELOW FRAME
PHOTO 1**

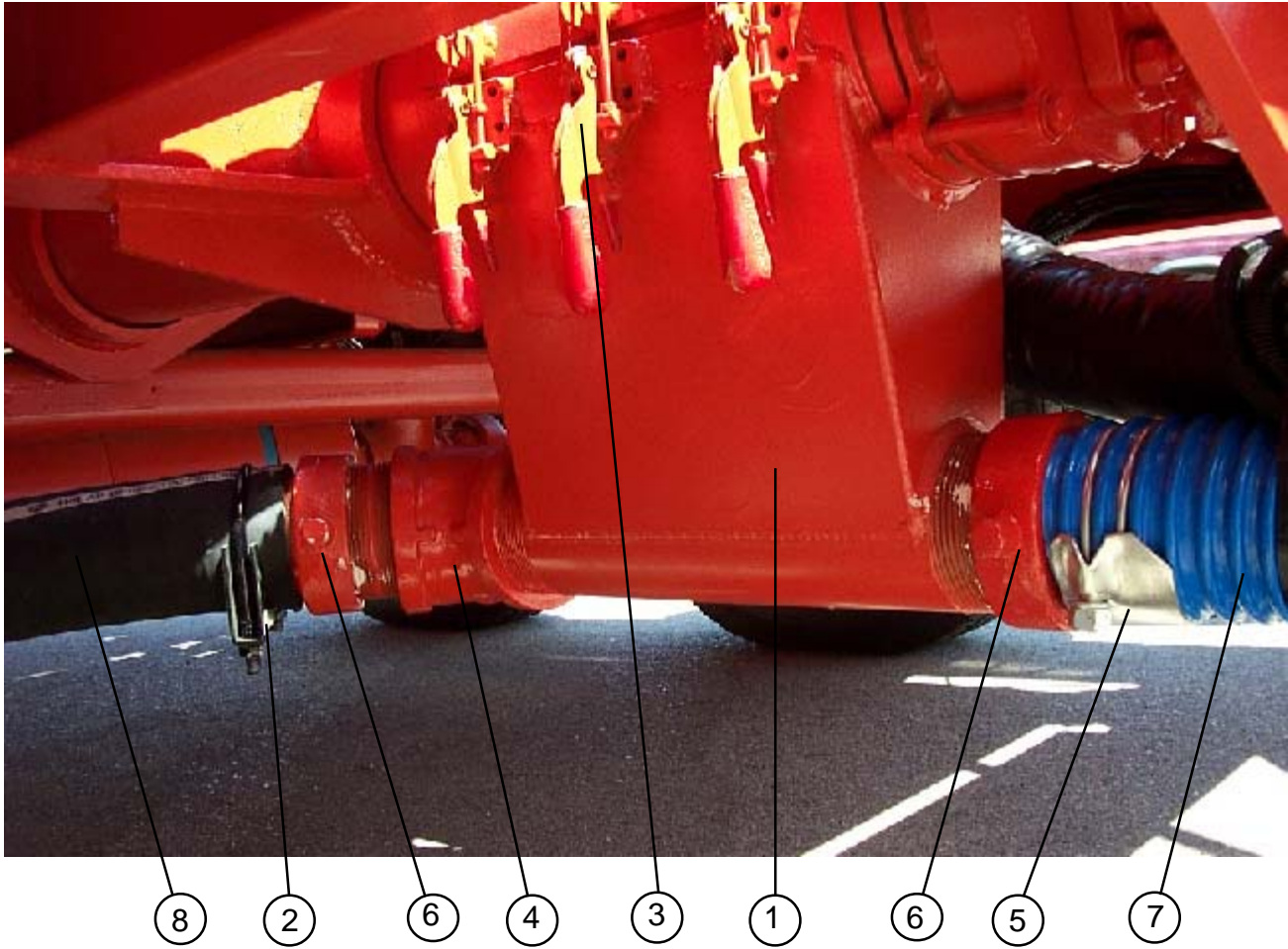

NUMBER	PART NUMBER	QTY	DESCRIPTION
1	91165	1	6" AIRLOCK COMPLETE
2	25952	1	3"-1/2 U-BOLT MUFFLER CLAMP
3	90606	1	PULL CLAMP 700#
4	28200	1	3" 45 DEGREE THREAD ELBOW
5	91855	1	HOSE CLAMP 3"- TIGER
6	90554	2	PIN PLUG 3" FEMALE LUG COUPLER
7	91157	1	3" BULK AGGRAGATE HOSE-BLUE
8	91338	1	3" WILDCAT HOSE X 28" LONG

AGGREGATE FEED SYSTEM, AIRLOCK SYSTEM - INSIDE FRAME PHOTO 2

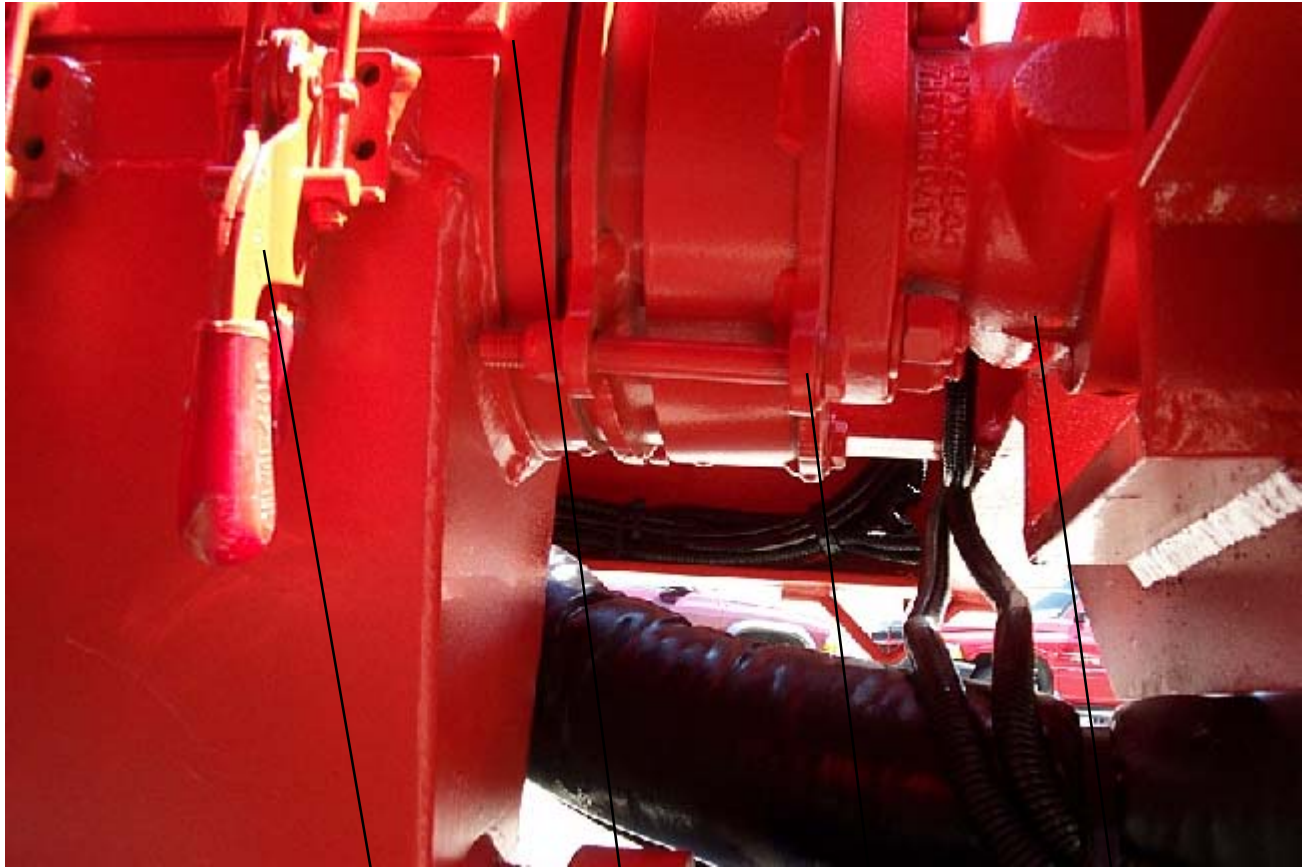

④

①

②

③

NUMBER	PART NUMBER	QTY	DESCRIPTION
1	91057	1	AIR LOCK GASKET
2	91121	1	MOTOR MOUNTING RING
3	91122	1	HYDRAULIC MOTOR
4	90606	3	PULL CLAMP 700 LBS.

FRONT VIEW OF MAGNUM - ENGINE COVER, JACK, AGGREGATE HOPPER, FRONT HITCH PLATE, CHAINS

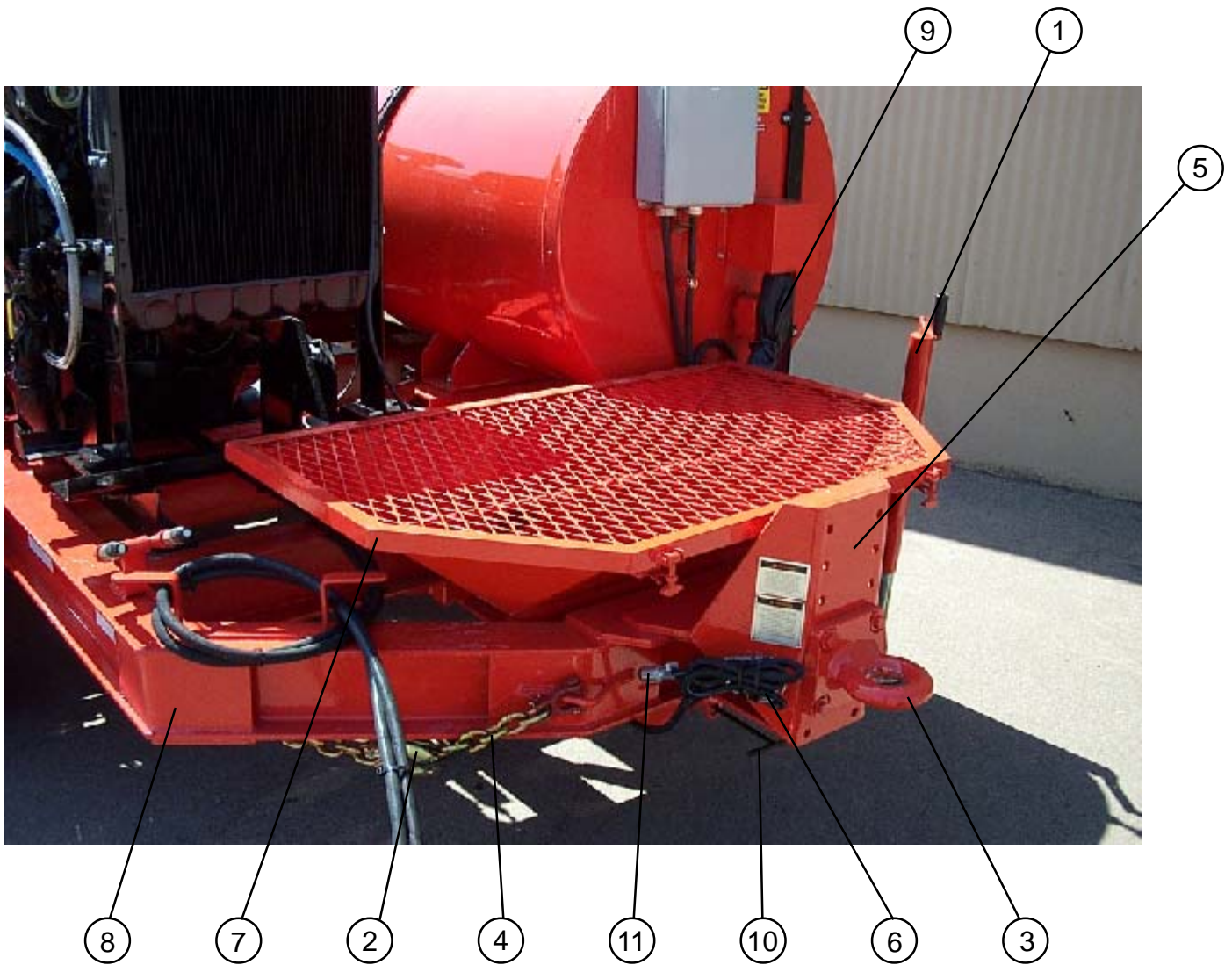

**FRONT VIEW OF MAGNUM - ENGINE COVER, JACK,
AGGREGATE HOPPER, FRONT HITCH PLATE, CHAINS**

NUMBER	PART NUMBER	QTY	DESCRIPTION
1	91576	1	JACK STAND
2	91781	1	3/8" SAFETY CHAIN HOOK
3	91850	1	2-1/2" ID EYE DROP FORGED STEEL DRAWBAR
4	90514	1	3/8" SAFETY CHAIN
5	90735	1	FRONT ASSEMBLY HITCH PLATE
6	91171	1	BREAK-AWAY BRCKT ACT SWITCH
7	91130	1	AGGREGATE HOPPER
8	91005	1	MAGNUM BASE FRAME
9	91207	1	EMULSION INSULATION HOSE COVER
10	91276	1	HOPPER DUMP DOOR PULL BAR
11	24074	1	6-WIRE TRAILER CONNECTOR

6" AGGREGATE SCREW FEED PIPE/TORFLEX AXLES AND TIRES AND RIMS



③

①

NUMBER	PART NUMBER	QTY	DESCRIPTION
1	60116	1	SILENCER RD 3"
2	42515	1	TIRE & RIM ASSEMBLY
3	91006	1	AXLE TORFLEX WITH ELECTRIC BRAKES
4	91053	1	6" AGGREGATE SCREW FEED PIPE ASSEMBLY

6" AGGREGATE SCREW FEED PIPE/TORFLEX AXLES AND TIRES AND RIMS



4

2

NUMBER	PART NUMBER	QTY	DESCRIPTION
1	60116	1	SILENCER RD 3"
2	42515	1	TIRE & RIM ASSEMBLY
3	91006	1	AXLE TORFLEX WITH ELECTRIC BRAKES
4	91053	1	6" AGGREGATE SCREW FEED PIPE ASSEMBLY

AGGREGATE HOPPER AND 6" AGGREGATE FEED SCREW ASSEMBLY

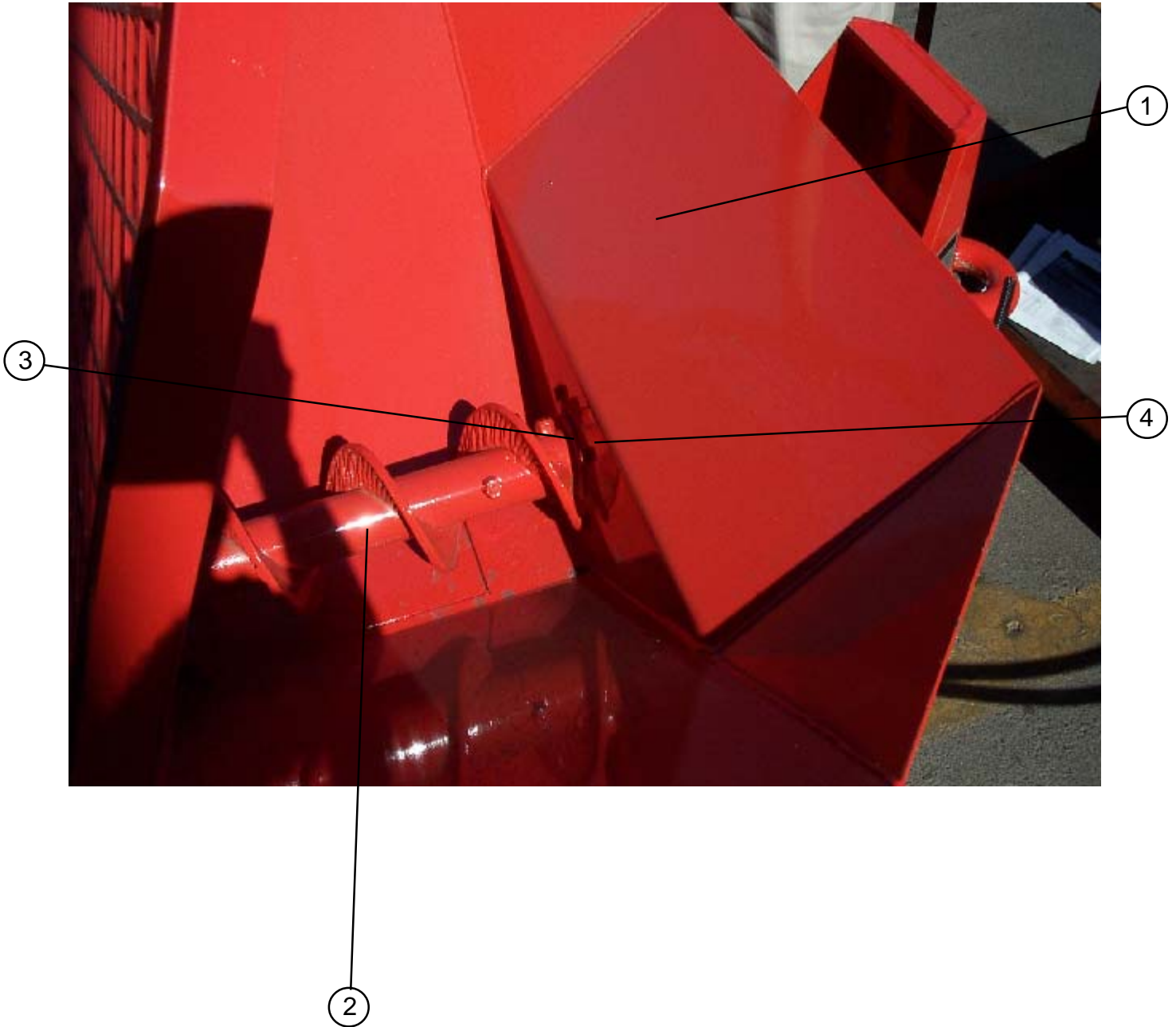

NUMBER	PART NUMBER	QTY	DESCRIPTION
1	91130	1	AGGREGATE HOPPER - MAGNUM
2	91054	1	6" AGGREGATE FEED SCREW
3	91265	1	ANTIFRICTION NYLON WASHER
4	91131	1	HOPPER BEARING (HIDDEN)(NOT SHOWN)

FRONT VIEW OF MAGNUM - BACK-UP ALARM, HOPPER SAFETY SWITCH

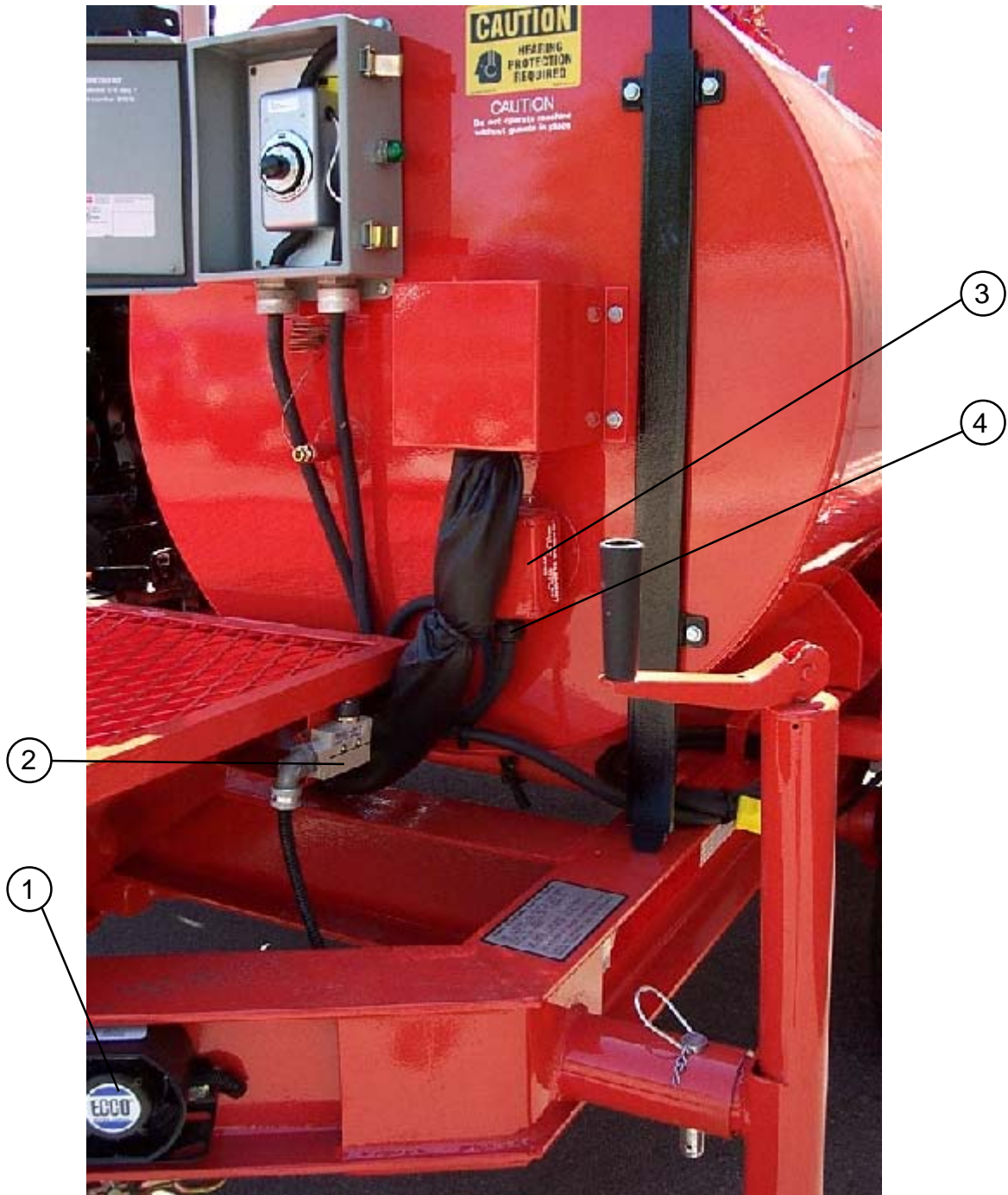

NUMBER	PART NUMBER	QTY	DESCRIPTION
1	91645	1	BACK-UP ALARM HEAVY DUTY
2	91133	1	HOPPER SAFETY SWITCH
3	91799	1	EMULSION TANK HEATER
4	91581	1	3/4" STRAIN RELIEF

AGGREGATE HOPPER FRONT BEARING



NUMBER	PART NUMBER	QTY	DESCRIPTION
1	91131	1	1-1/4" HOPPER BEARING

REAR PASSENGER SIDE VIEW OF MAGNUM - DIESEL FLUSH TANK, FUEL TANK, BATTERY



NUMBER	PART NUMBER	QTY	DESCRIPTION
1	90640	1	250 GALLON EMULSION TANK WITH INSULATION
2	90703	1	2" PIPE PLUG WITH PSI RELIEF HOLE
3	29281	1	2" BRASS BALL VALVE
4	90860	1	30 GALLON DIESEL TANK ASSEMBLY
5	91815	1	1/4" DRAIN PET COCK
6	90200	1	BATTERY LOCK BOX ASSEMBLY
7	91510	1	FUEL TANK COMPLETE
8	43579	1	PRESSURE FILTER BREATHER CAP
9	90563	1	FUEL LEVEL GAUGE
10	91299	1	SQUARE RED REFLECTOR

BATTERY BOX

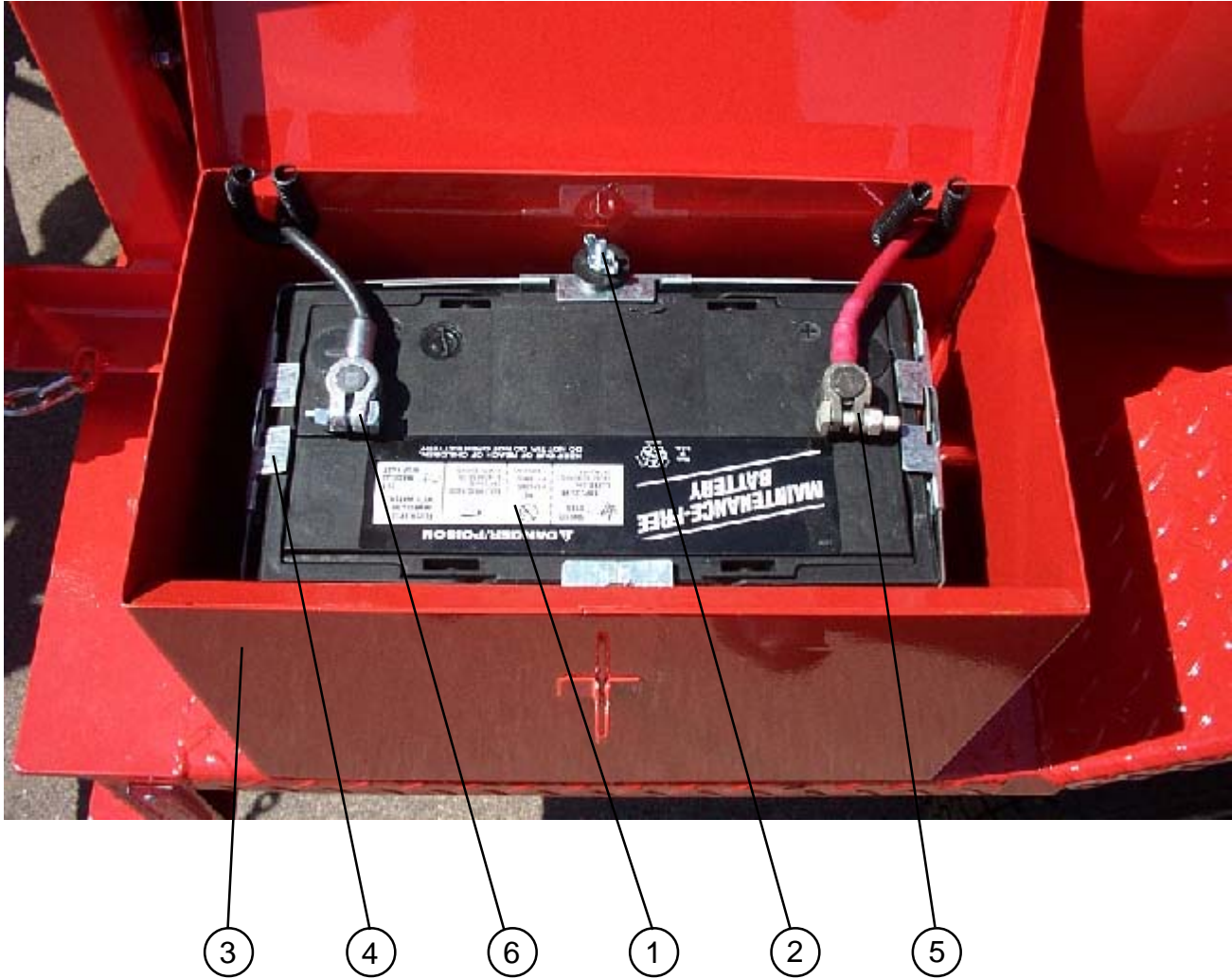

NUMBER	PART NUMBER	QTY	DESCRIPTION
1	24001	1	1000 C.C.A. BATTERY
2	32030	1	BATTERYHOOK BOLTS
3	90200	1	BATTERY LOCK BOX ASSEMBLY
4	24005	1	BATTERY HOLD DOWN FRAME
5	90905	1	BATTERY CABLE 93" LONG
6	32602	1	20" CRESCENT BATTERY CABLE

EMULSION TANK, CRACK FILLING ATTACHMENT (OPTION)

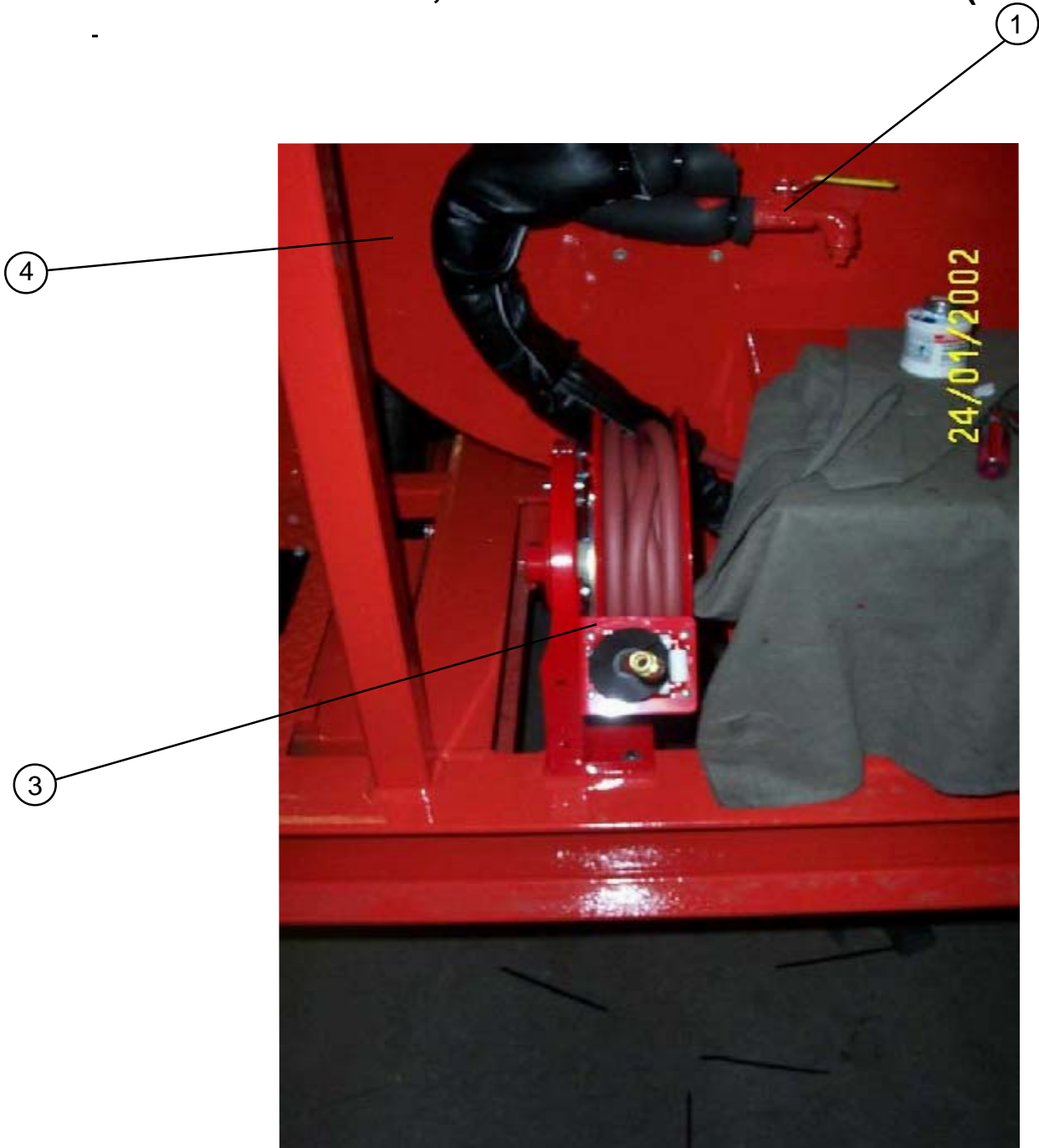

NUMBER	PART NUMBER	QTY	DESCRIPTION
1	90628	1	EMULSION TANK REAR VALVE ASSEMBLY
2	91530	1	DEEP NOZZLE STORAGE AND BOX
3	90780	1	CRACK FILLING ATTACHMENT ASSEMBLY
4	90640	1	250 GAL EMULSION TANK WITH INSULATION

CRACK FILLING ATTACHMENT - OPTION

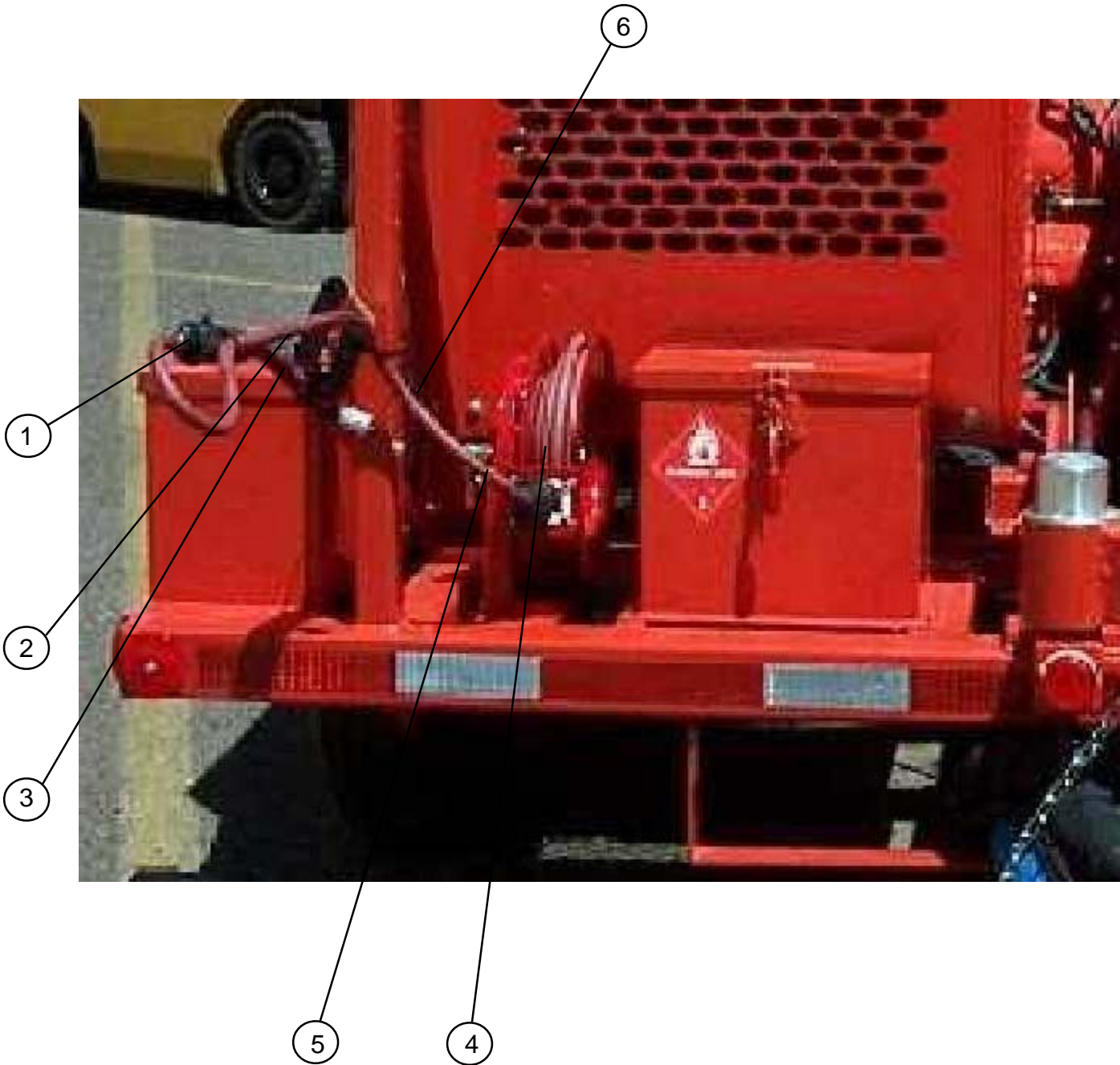

NUMBER	PART NUMBER	QTY	DESCRIPTION
1	90782	1	TACK WAND COMPLETE ASSEMBLY
2	90772	1	TACK WAND GRIP HANDLE ASSEMBLY
3	91825	1	QUICK COUPLER 1/4" MPT X 1/4" FM AIR
4	90777	1	TACK WAND SUPPLY HOSE STOW REEL
5	90778	1	HOSE STOP-RUBBER-ORANGE
6	90771	1	TANK WAND SUPPLY HOSE 25 FEET

DIESEL STORAGE TANK

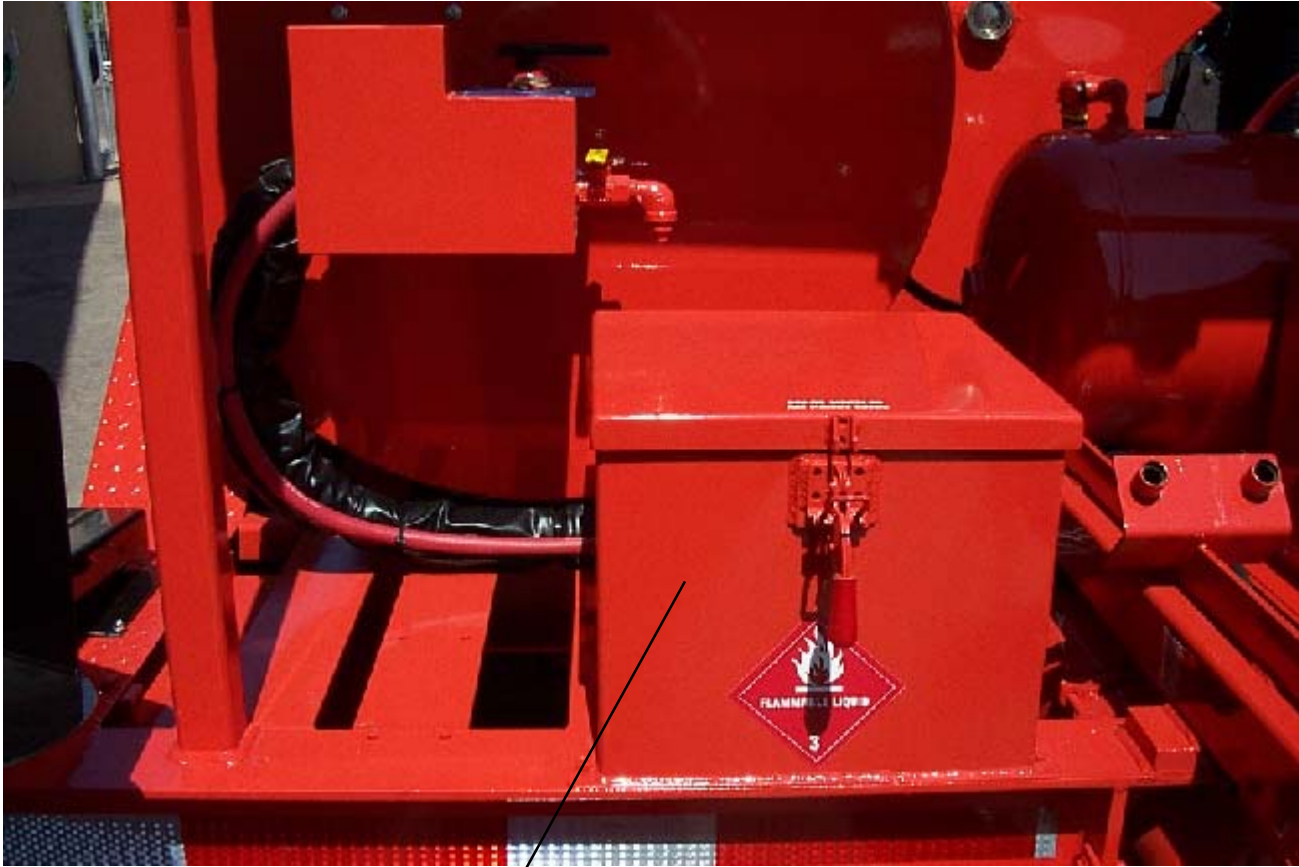

1

NUMBER	PART NUMBER	QTY	DESCRIPTION
1	91530	1	DEEP NOZZLE STORAGE BOX

DIESEL FLUSH TANK/FUEL TANK



NUMBER	PART NUMBER	QTY	DESCRIPTION
1	90860	1	DIESEL FLUSH TANK ASSEMBLY
2	91510	1	FUEL TANK COMPLETE
3	90815	1	HYDRAULIC TANK-COMPLETE ASSEMBLY

STORBE LIGHT-OPTION



1

NUMBER	PART NUMBER	QTY	DESCRIPTION
1	91440	1	STROBE LIGHT KIT (OPTIONAL)

EMULSION TANK, TOP VALVE ASSEMBLY



NUMBER	PART NUMBER	QTY	DESCRIPTION
1	90629	1	EMULSION TANK TOP VALVE ASSEMBLY
2	29961	1	PRESURE GAUGE
3	91135	1	1/4" PIPE "PIG TAIL"
4	42629	1	SAFETY VALVE
5	90861	1	1/2" CHECK VALVE
6	90640	1	250 GAL. EMULSION TANK WITH INSULATION
7	29214	1	BRONZE BALL VALVE - 1/2"
8	41243	1	24" TEMPERATURE GAUGE BOTTOM MOUNT

EMULSION TANK TEMPERATURE GAUGE



8

FRONT VIEW OF EMULSION TANK AND COMPONENTS



④ ② ① ③

NUMBER	PART NUMBER	QTY	DESCRIPTION
1	91799	1	EMULSION TANK HEATER
2	25203	1	STUFFING BOX
3	91207	1	EMULSION INSTALLATION HOSE COVER
4	91095	1	THERMOSTAT BOX ASSEMBLY

REAR DRIVER'S SIDE - FLUSH OUT BOX AND TROUGH OF MACHINE



3

2

4

1

NUMBER	PART NUMBER	QTY	DESCRIPTION
1	91140	1	NEW STYLE TROUGH
2	91299	1	SQUARE RED REFLECTOR
3	91200	1	FLUSH OUT BOX
4	29270	1	BRONZE GATE VALVE - 2"

REAR DRIVER'S SIDE - FLUSH OUT BOX AND TROUGH OF MACHINE



- ①
④
②
③

NUMBER	PART NUMBER	QTY	DESCRIPTION
1	91140	1	NEW STYLE TROUGH
2	91200	1	FLUSH OUT BOX
3	91267	1	BOTTOM FLANGE GASKET - TROUGH
4	91259	1	BOTTOM FLANGE GASKET COVER - TROUGH

EMULSION TANK REAR VALVE ASSEMBLY



③ ② ①

NUMBER	PART NUMBER	QTY	DESCRIPTION
1	90628	1	EMULSION TANK REAR VALVE ASSEMBLY
2	90569	1	VALVE POSITION INDICATOR PLATE
3	90207	1	EMULSION TANK INSULATION BOX

CONTROL CONSOLE PANEL

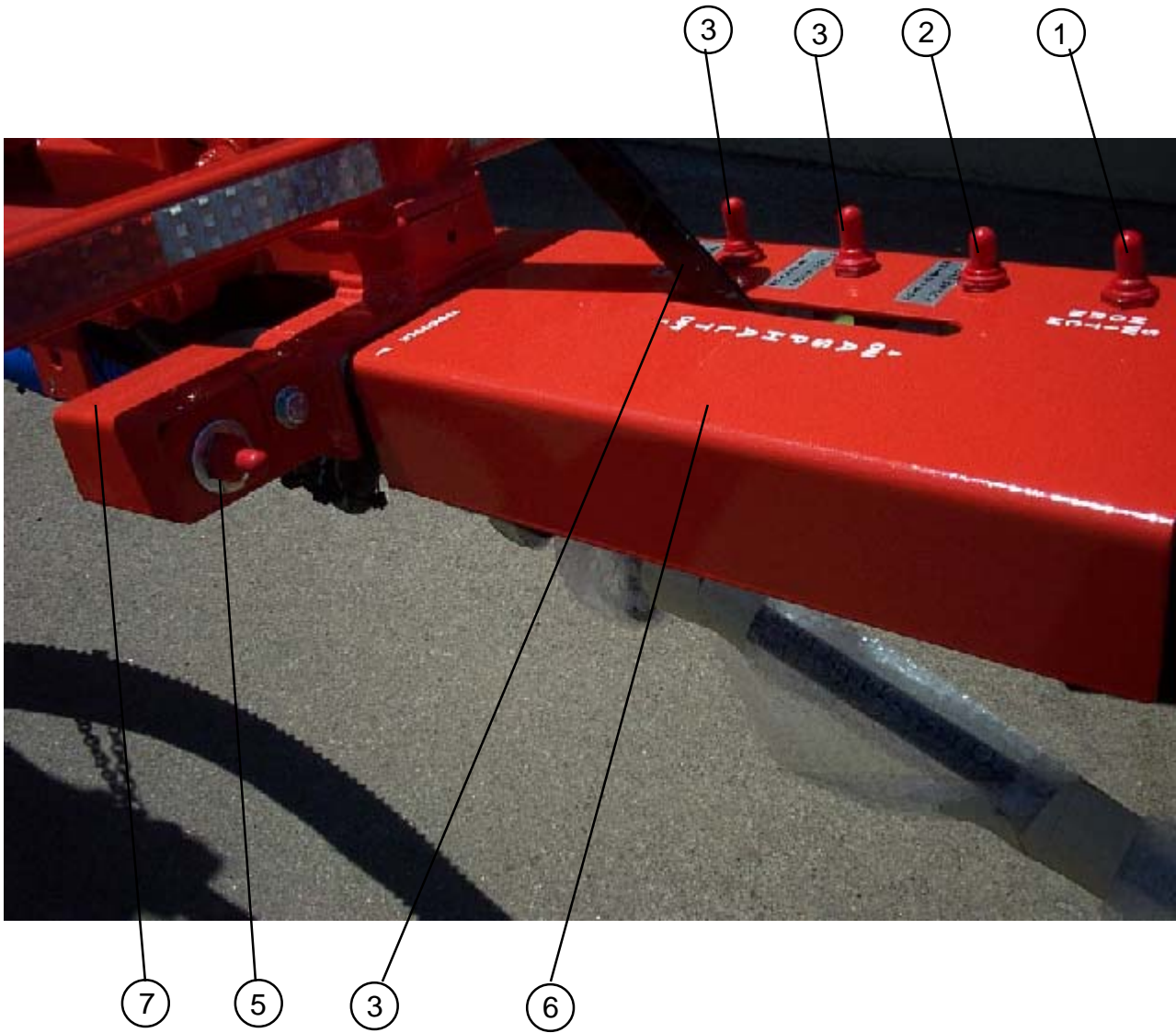

NUMBER	PART NUMBER	QTY	DESCRIPTION
1	50719	1	HORN SWITCH
2	32580	1	STONE SWITCH
3	51678	1	MOMENTARY SWITCH
4	91700	1	EMULSION REGULATION VALVE ASSEMBLY
5	32513	1	THROTTLE SWITCH
6	91230	1	CONTROL PANEL ASSEMBLY
7	90212	1	REMOTE CONTROL ACTUATOR SWITCH COVER

ENGINE AND ENGINE COVER/COMPONENTS

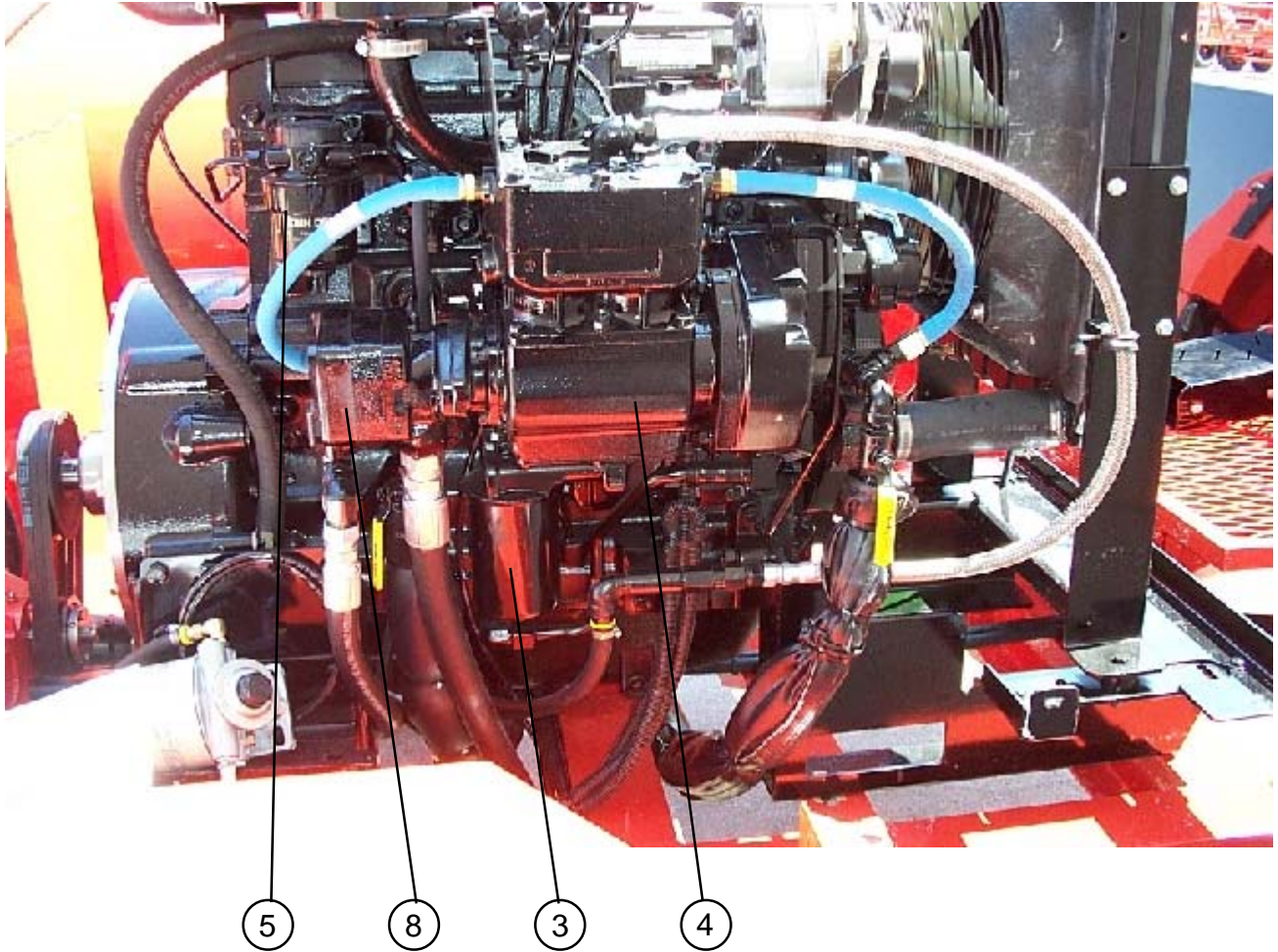

NUMBER	PART NUMBER	QTY	DESCRIPTION
1	91048	1	MUFFLER EXHAUST JOHN DEERE (NOT SHOWN)
2	91030	1	ENGINE COVER (JOHN DEERE T040450)
3	91044	1	OIL FILTER - ENGINE
4	91015	1	ENGINE (JOHN DEERE WITH COVER & COMPRESSOR)
5	91042	1	ENGINE FUEL FILTER
6	91031	1	INLET HOOD - LARGE BLOWER AIR CLEANER (NOT SHOWN)
7	91029	1	INLET HOOD SMALL AIR CLEANER (NOT SHOWN)
8	90800	1	HYDRAULIC PUMP JOHN DEERE ENGINE WITH COMPRESSOR
9	91727	1	RUBBER CHECK VALVE - AIR CLEANER (NOT SHOWN)

DRIVE TRAIN SYSTEM - ENGINE TO BLOWER/BELT DRIVE

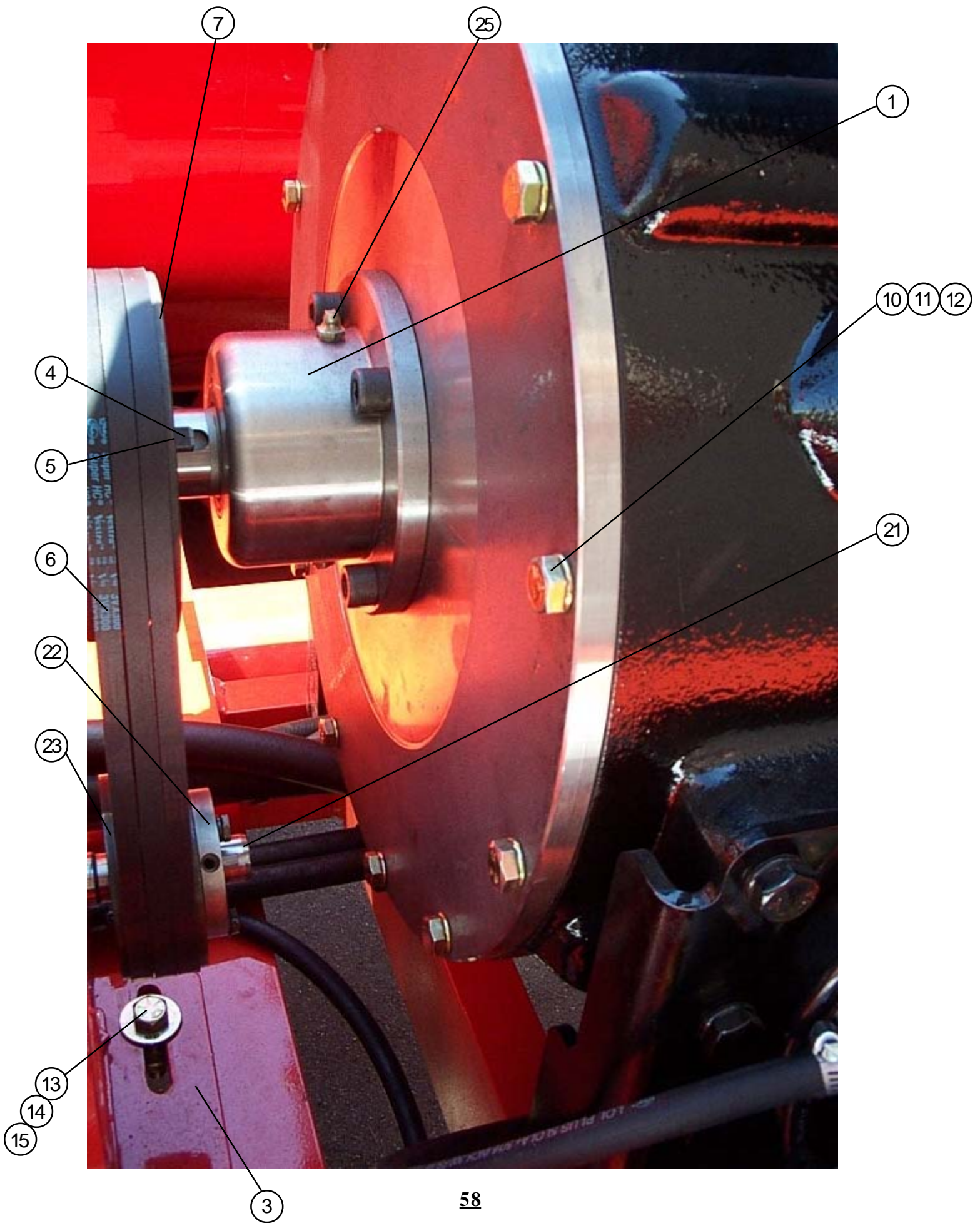

DRIVE TRAIN SYSTEM - ENGINE TO BLOWER/BELT DRIVE

NUMBER	PART NUMBER	QTY	DESCRIPTION
1	91335	1	BEARING SUPPORT STUB SHAFT
2	60151	1	POSITME DISPLACEMENT ROTARY (NOT SHOWN)
3	91330	1	BLOWER SLID PLATE - MAGNUM
4	91409	1	SDS 1-1/2" BUSHING WITH 3/8"
5	91326	1	ENGINE SHIFT KEY 3/8" - HARDEN
6	92303	3	3V X 300 SUPER HC V-BELT
7	92304	1	3/3V 6.0" QD-SDS SHEAVE
8	60191	0.02	OIL-ROTARY AIR BLOWER (NOT SHOWN)
9	27953	8	3/8"-16 NC X 1" GR8 HEX HEAD (NOT SHOWN)
10	28641	20	3/8" FLAT HARDENED WASHER
11	28658	20	3/8" LOCK WASHER GRADE 8
12	27955	12	3/8"-16NC X 1-1/4" GRADE 8 HEX HEAD
13	28528	8	1/2"-13 ESNA LOCK-NUT
14	28659	8	1/2" LOCK WASHER GRADE 8
15	29026	8	1/2"-13 X 1-1/2" GRADE 8 BOLT
16	90858	2	3/8"-16 X 4 FULL THREAD BOLT (NOT SHOWN)
17	28526	2	3/8"-16 ESNA LOCK NUT (NOT SHOWN)
18	27986	2	3/8" FLAT WASHER GRADE 8 (NOT SHOWN)
19	27964	2	3/8"-16NC GRADE 8 NUT (NOT SHOWN)
20	90827	8	BLOWER MOUNTING TAB
21	91065	1	BLOWER KEY - 1/4"
22	92306	1	7/8" SH BUSHING
23	92302	1	3/3V 3.65" QD-SH SHEAVE
24	91327	1	BLOWER KEY - 3/16" X 1-7/8" (NOT SHOWN)
25	-----	2	GREASE -- HERE

HYDRAULIC TAILGATE AND COMPONENTS

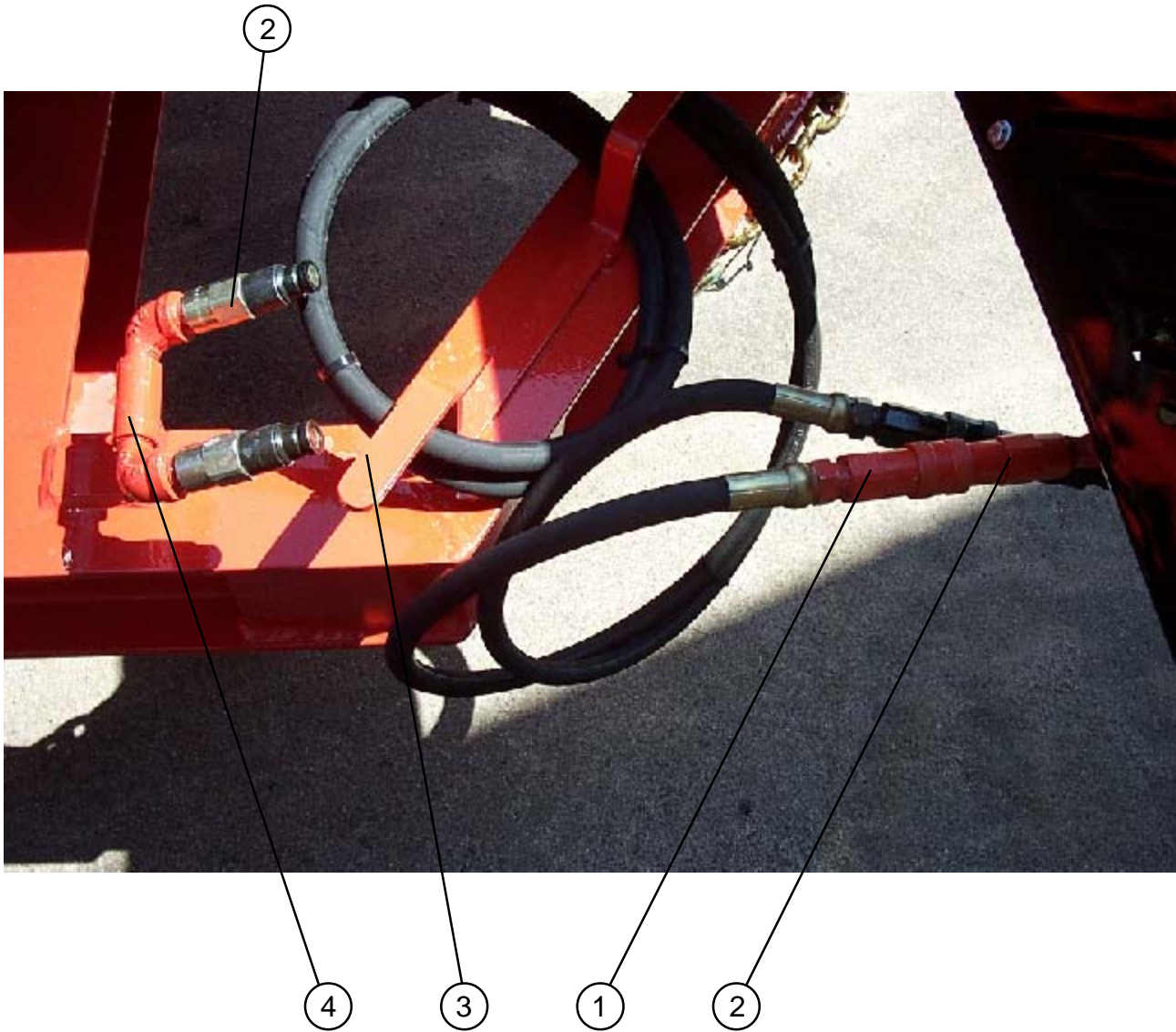

NUMBER	PART NUMBER	QTY	DESCRIPTION
1	91242	2	1/2" HOLMBURY SOCKET - FEMALE
2	91243	2	1/2 HOLMBURY SOCKET - MALE
3	91281	1	HYDRAULIC HOSE STORAGE BRACKET
4	91244	1	STATIONARY FRAME HYDRAULIC SOCKET ASSEMBLY

THERMOSTAT BOX AND COMPONENTS



1

2

3

NUMBER	PART NUMBER	QTY	DESCRIPTION
1	91095	1	THERMOSTAT BOX ASSEMBLY
2	91215	1	THERMOSTAT
3	90542	1	LIGHT
4	41157	0.25	INSULATION (NOT SHOWN)

DIESEL FLUSH TANK



NUMBER	PART NUMBER	QTY	DESCRIPTION
1	90860	1	DIESEL FLUSH TANK ASSEMBLY
2	90861	1	1/2" CHECK VALVE
3	28253	1	1/2" PIPE TEE
4	28238	1	1/2" STREET ELBOW
5	29596	1	HOSE - 1/2" PUSH-ON-BLACK

VIEW OF AIRLOCK SYSTEM AND COMPONENTS UNDER REAR OF MACHINE

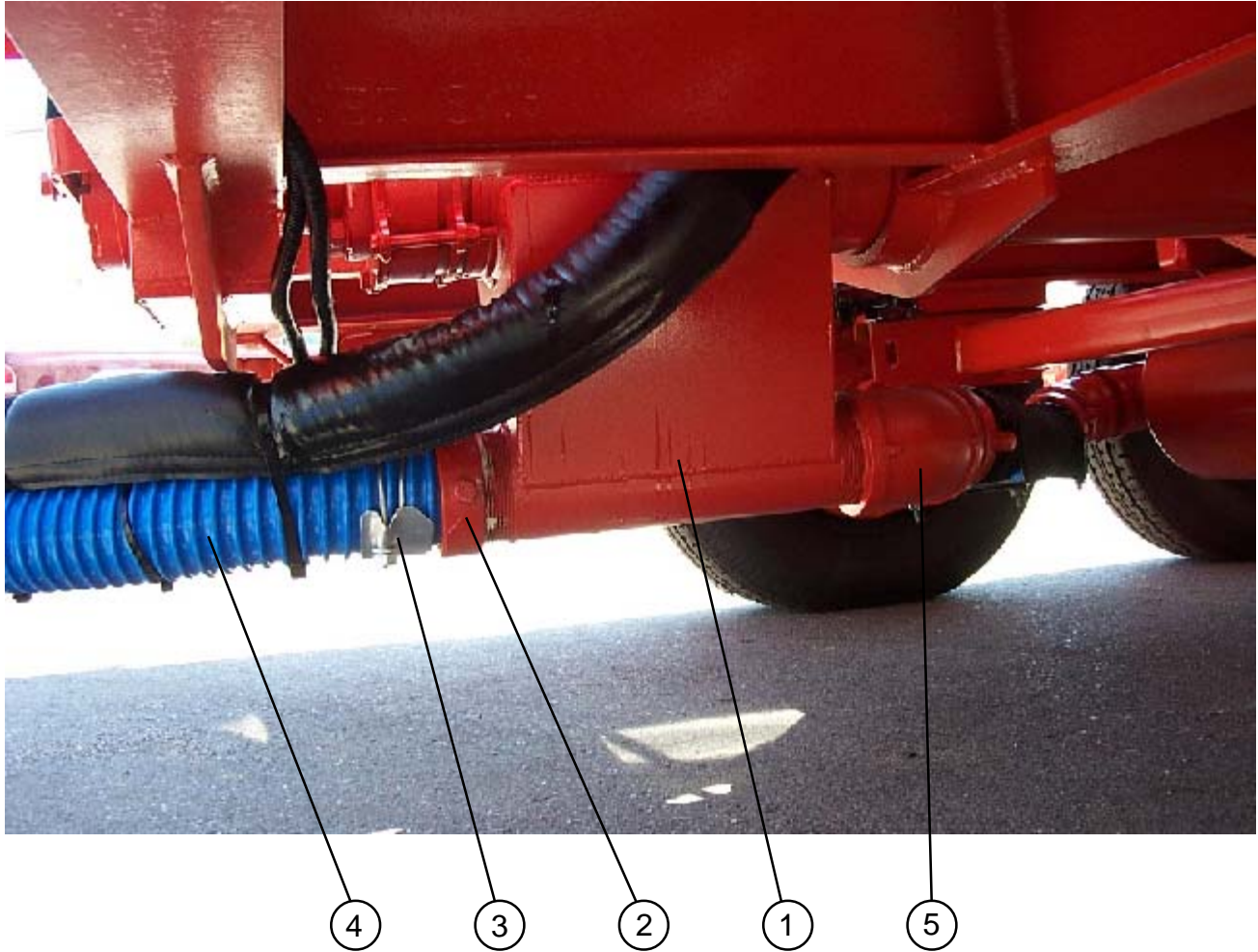

NUMBER	PART NUMBER	QTY	DESCRIPTION
1	91165	1	6" AIR LOCK COMPLETE
2	90554	2	PIN PLUG/3" FEMALE COUPLER
3	91855	1	3" TIGER HOSE CLAMP
4	91157	1	13 FT. - 3" AGGREGATE HOSE/BLUE
5	28200	1	3" 45 DEG. THREADED ELBOW

VIEW OF AIRLOCK SYSTEM REAR AND COMPONENTS REAR OF THE MACHINE

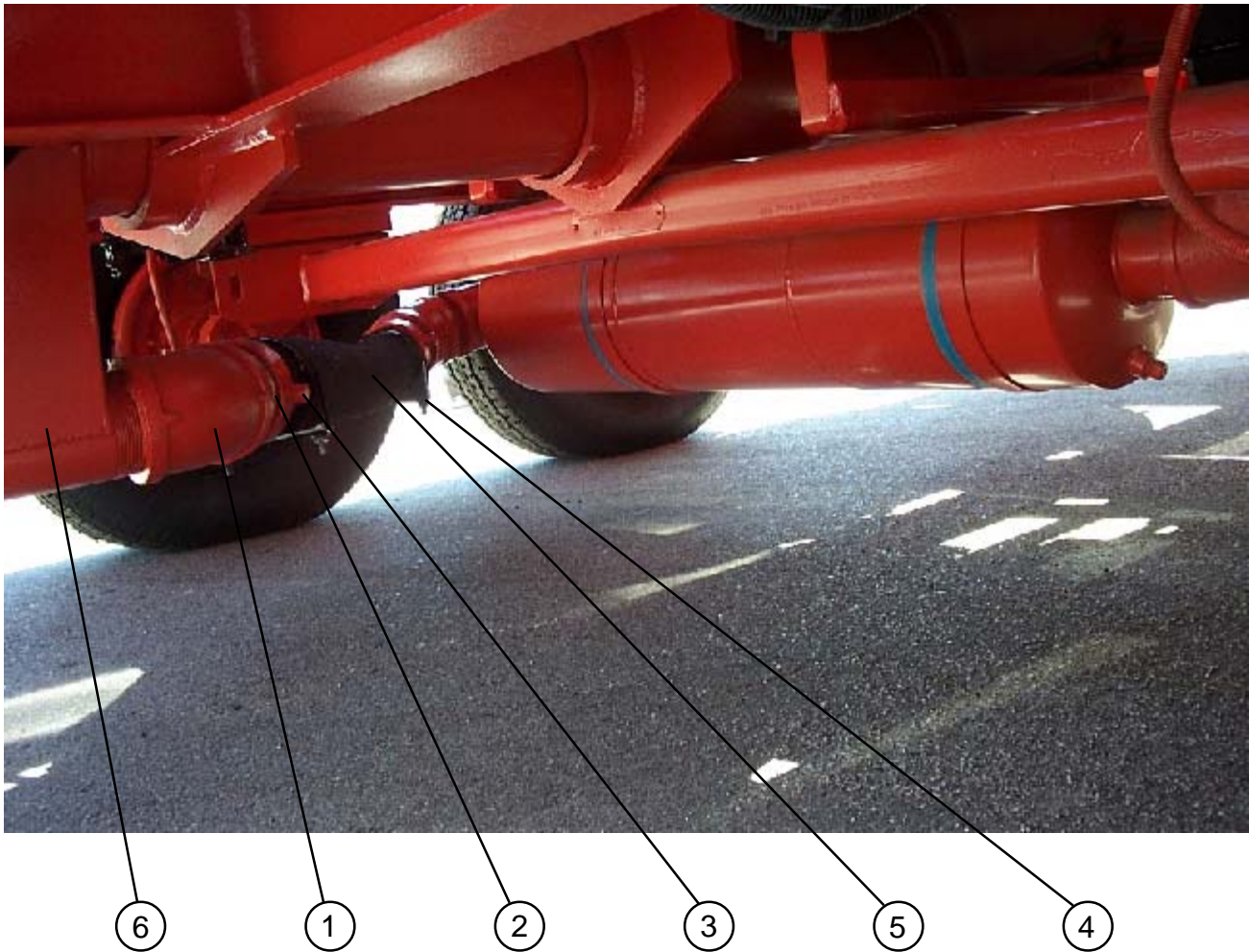

NUMBER	PART NUMBER	QTY	DESCRIPTION
1	28200	1	3" 45 DEG. THREADED ELBOW
2	28010	1	3" CLOSED NIPPLE
3	90554	1	PIN PLUG 3" FEMALE LUF COUPLER
4	25952	1	3-1/2" U-BOLT MUFFLER CLAMP
5	91338	1	3" WILDCAT HOSE X 28" LG.
6	91165	1	6" AIR LOCK COMPLETE

ENGINE AIR COMPRESSOR AND COMPRESSOR GOVERNOR

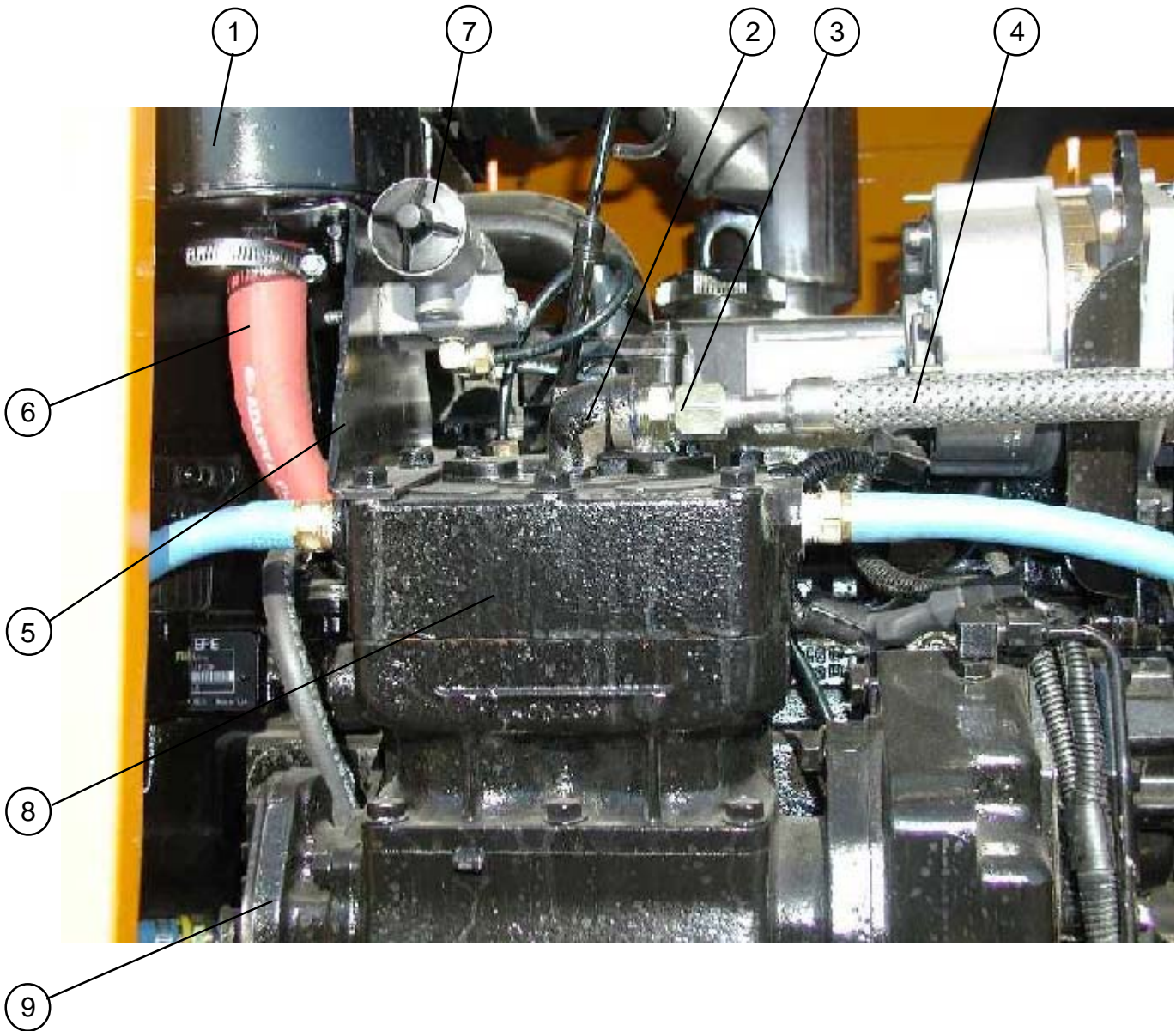

NUMBER	PART NUMBER	QTY	DESCRIPTION
1	50109	1	AIR COMPRESSOR FILTER
2	28238	1	1/2" STREET ELBOW
3	29844	1	1/2" MPT X 1/2" 37° ADAPTER
4	41403	1	1/2" STAINLESS STEEL LINE
5	90890	1	BRACKET
6	90891	1	INTAKE AIR COMPRESSOR HOSE
7	90899K	1	GOVERNOR - COMPRESSOR UNLOADING
8	91022	1	ENGINE - BOLT ON AIR COMPRESSOR
9	90800	1	HYDRAULIC MOTOR

WATER PUMP OUTLET HEATING VALVE

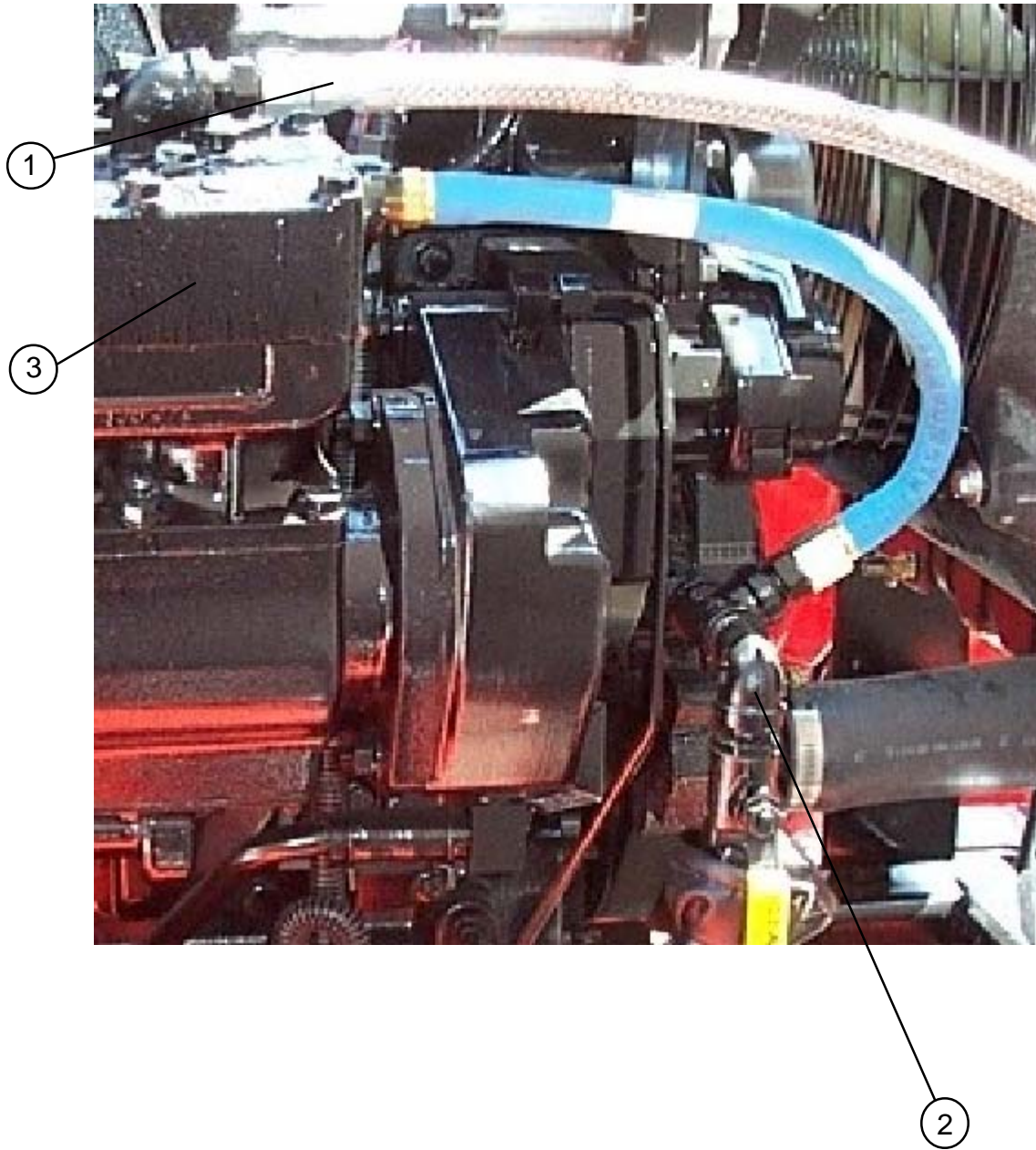

NUMBER	PART NUMBER	QTY	DESCRIPTION
1	41403	1	1/2" STAINLESS LINE
2	90530	1	WATER PUMP OUTLET HEATING VALVE
3	91022	1	ENGINE BOLT ON 13CFM COMPRESSOR J.D. ENGINE

HYDRAULIC SYSTEM

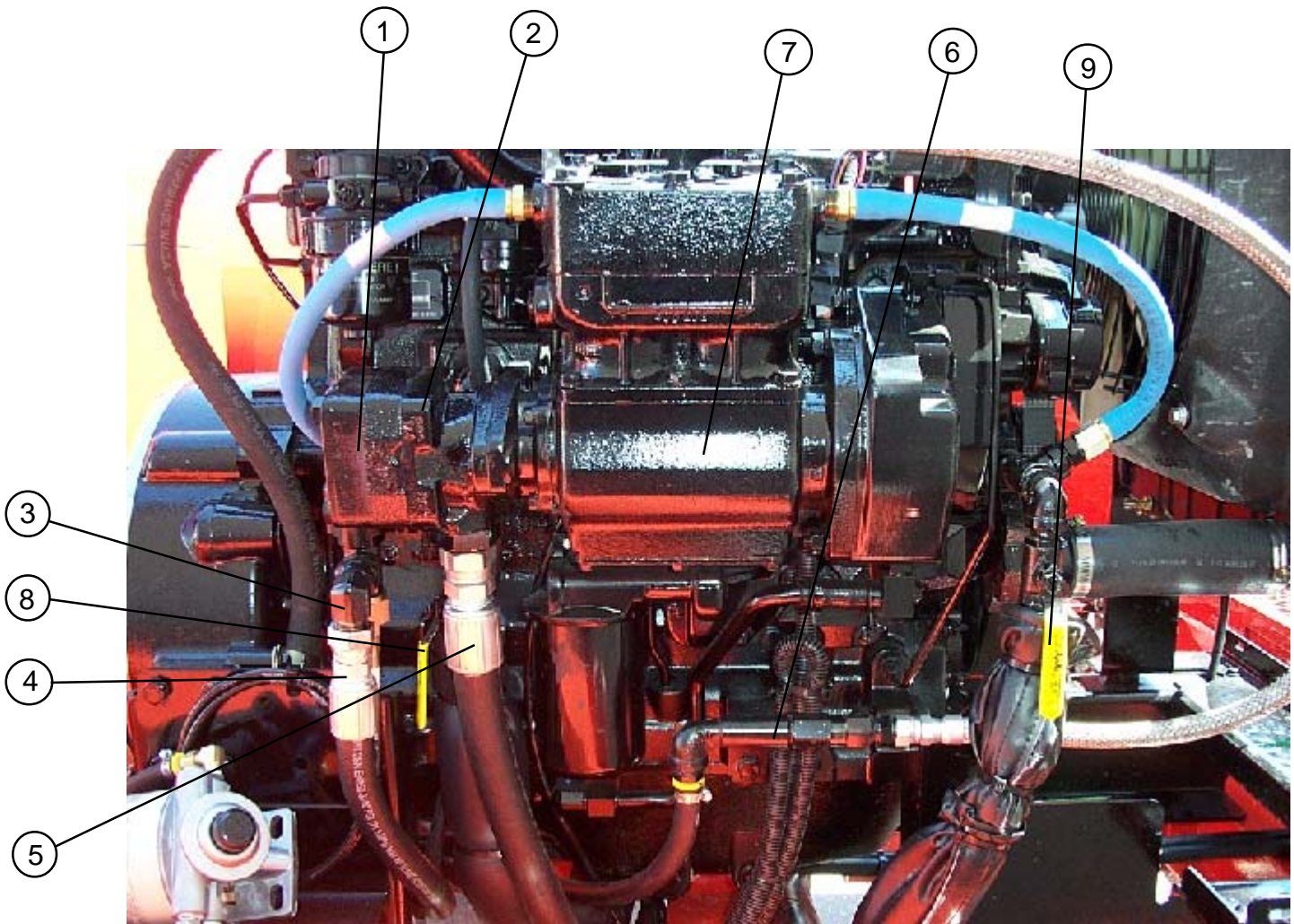

NUMBER	PART NUMBER	QTY	DESCRIPTION
1	90794	1	HYDRAULIC PUMP FITTING ASSEMBLY
2	90800	1	HYDRAULIC PUMP J.D. W/C COMPRESSOR
3	27694	1	3/4 INT JIC 1/4 EXT STRAIGHT CONNECTOR
4	XXXXX	1	AX12-12FJ-12FJ-72
5	XXXXX	1	AX16-16FJ-16FJ-65
6	90895	1	ON-BOARD COMPRESSOR CHECK VALVE
7	91022	1	ENGINE BOLT ON 13 C.F.M. COMPRESSOR- JOHN DEERE ENGIND
8	90529	1	RETURN WATER HEATING VALVE ASSEMBLY
9	90530	1	WATER PUMP OUTLET VALVE ASSEMBLY

WATER PUMP OUTLET HEATING VALVE

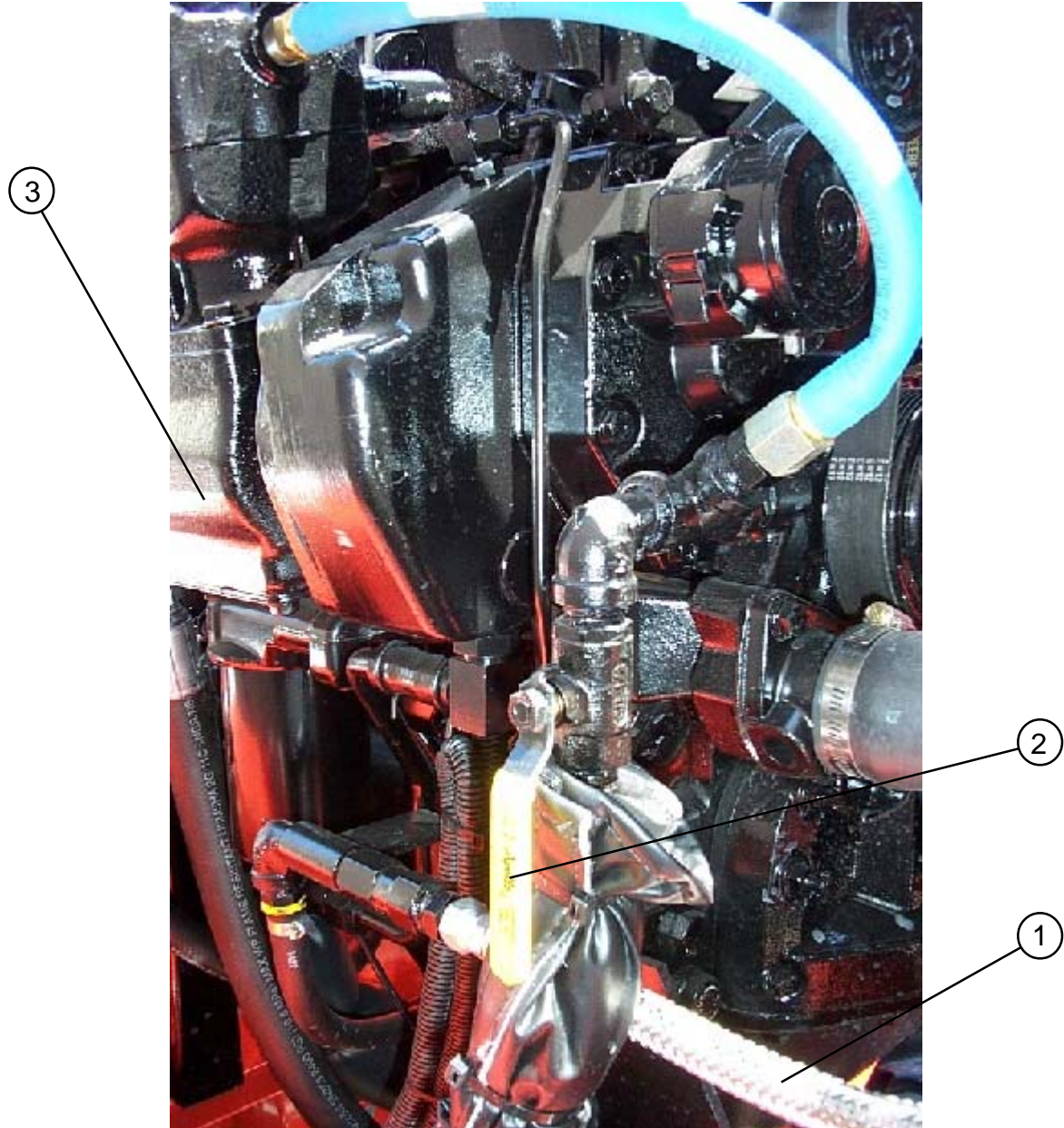

NUMBER	PART NUMBER	QTY	DESCRIPTION
1	41403	1	1/2" STAINLESS LINE
2	90530	1	WATER PUMP OUTLET HEATING VALVE
3	91022	1	ENGINE BOLT ON 13CFM COMPRESSOR J.D. ENGINE

ON-BOARD COMPRESSOR CHECK VALVE ASSEMBLY

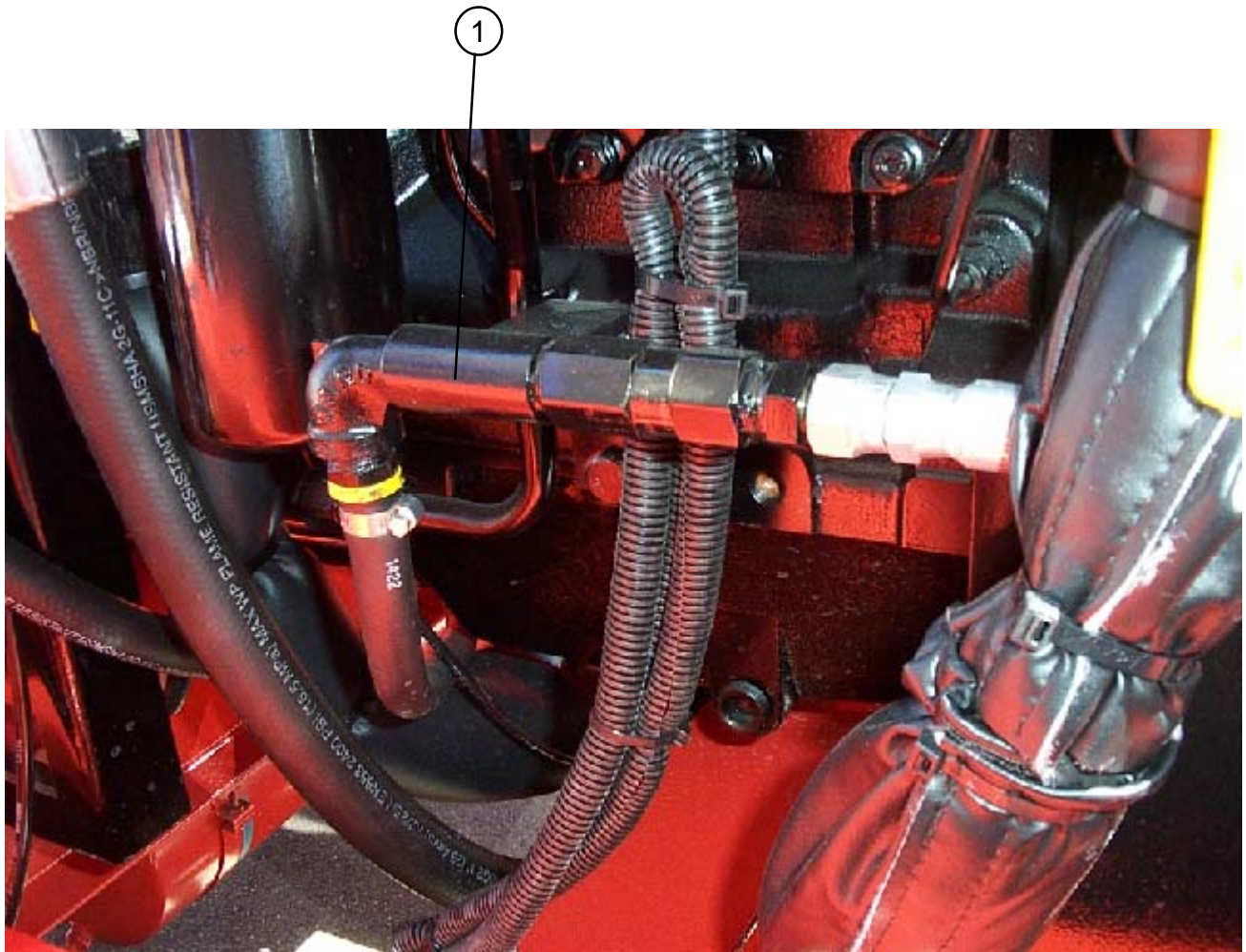

NUMBER	PART NUMBER	QTY	DESCRIPTION
1	90893	1	ON-BOARD COMPRESSOR CHECK VALVE ASSEMBLY

RETURN WATER HEATING VALVE ASSEMBLY

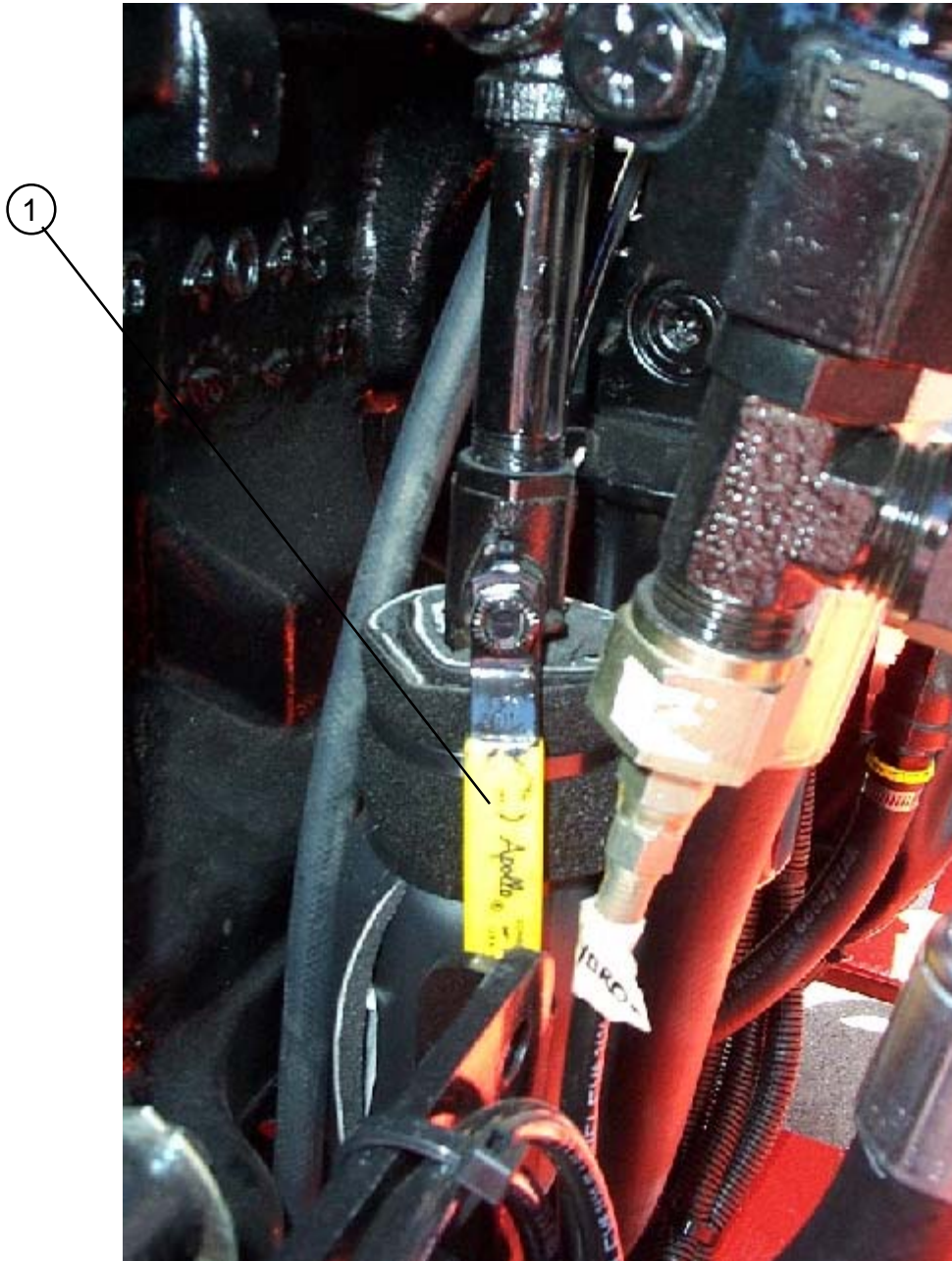

NUMBER	PART NUMBER	QTY	DESCRIPTION
1	90530	1	WATER PUMP OUTLET VALVE ASSEMBLY

JOHN DEERE ENGINE COMPONENTS

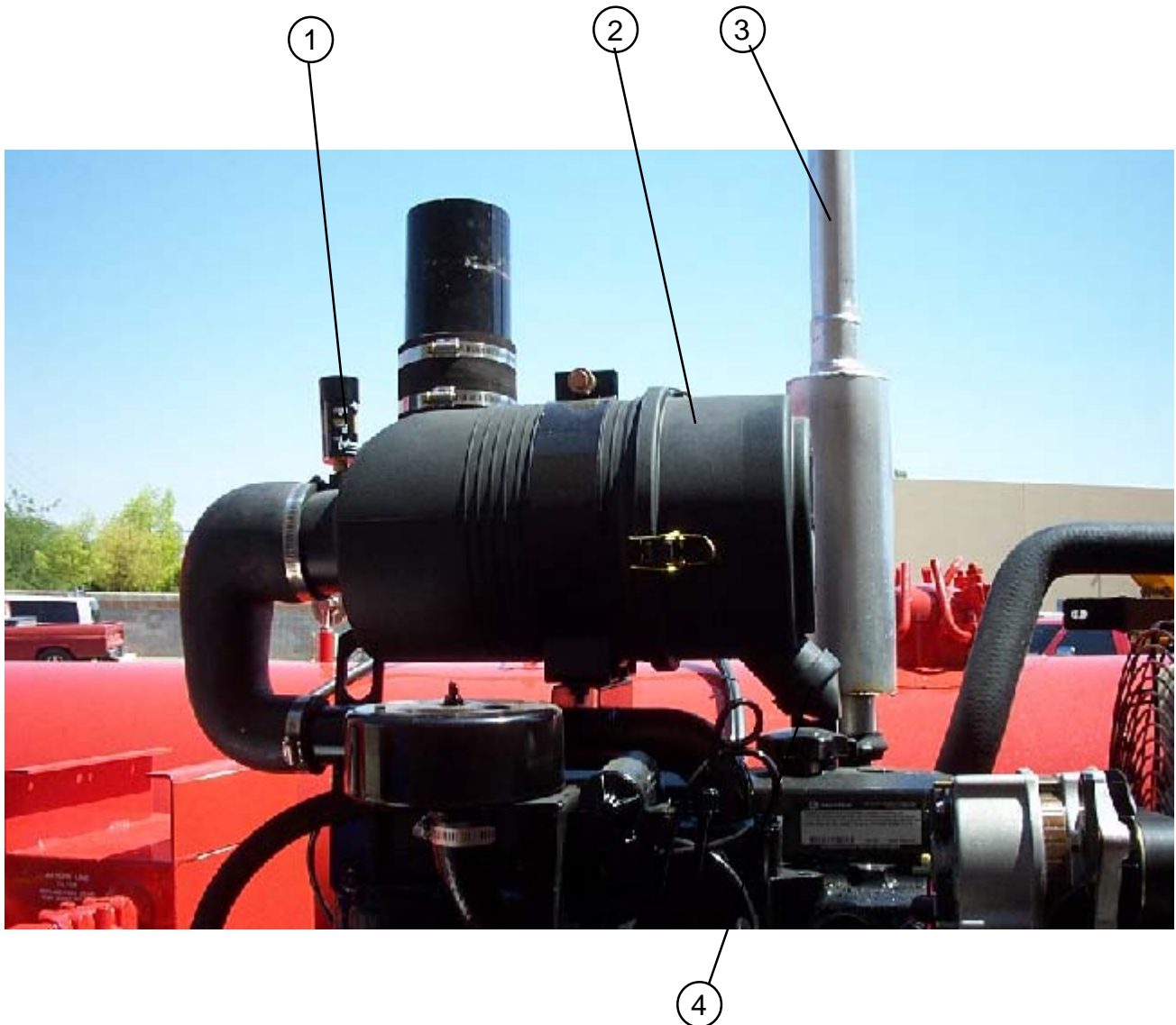

NUMBER	PART NUMBER	QTY	DESCRIPTION
1	91795	1	AIR FILTER RESTRICTION INDICATOR
2	-----	1	AIR CLEANER HOUSING-SUPPLIED BY JOHN DEERE
3	-----	1	EXHAUST SYSTEM-SUPPLIED BY JOHN DEERE
4	91727	1	RUBBER CHECK VALVE-AIR CLEANER
5	91028	1	JOHN DEERE OPERATION & MAINTENANCE MANUAL

MAGNUM BLOWER AIR CLEANER



NUMBER	PART NUMBER	QTY	DESCRIPTION
1	91045	1	AIR CLEANER COMPLETE
2	91035	1	AIR CLEANER-AIR FILTER
3	91031	1	INLET HOOD-SMALL HOOD
4	91795	1	AIR FILTER RESTRICTION INDICATOR
5	91708	2	AIR CLEANER MOUNTING RING
6	91235	1	RUBBER CONNECTOR HOSE-BLOWER
7	91843	1	6" WORM-DRIVE HOSE CLAMP
8	91727	1	RUBBER CHECK VALVE-AIR CLEANER

MAGNUM BLOWER AIR CLEANER



NUMBER	PART NUMBER	QTY	DESCRIPTION
1	91035	1	AIR CLEANER-AIR FILTER

ALUMINUM HYDRAULIC CIRCUIT MANIFOLD

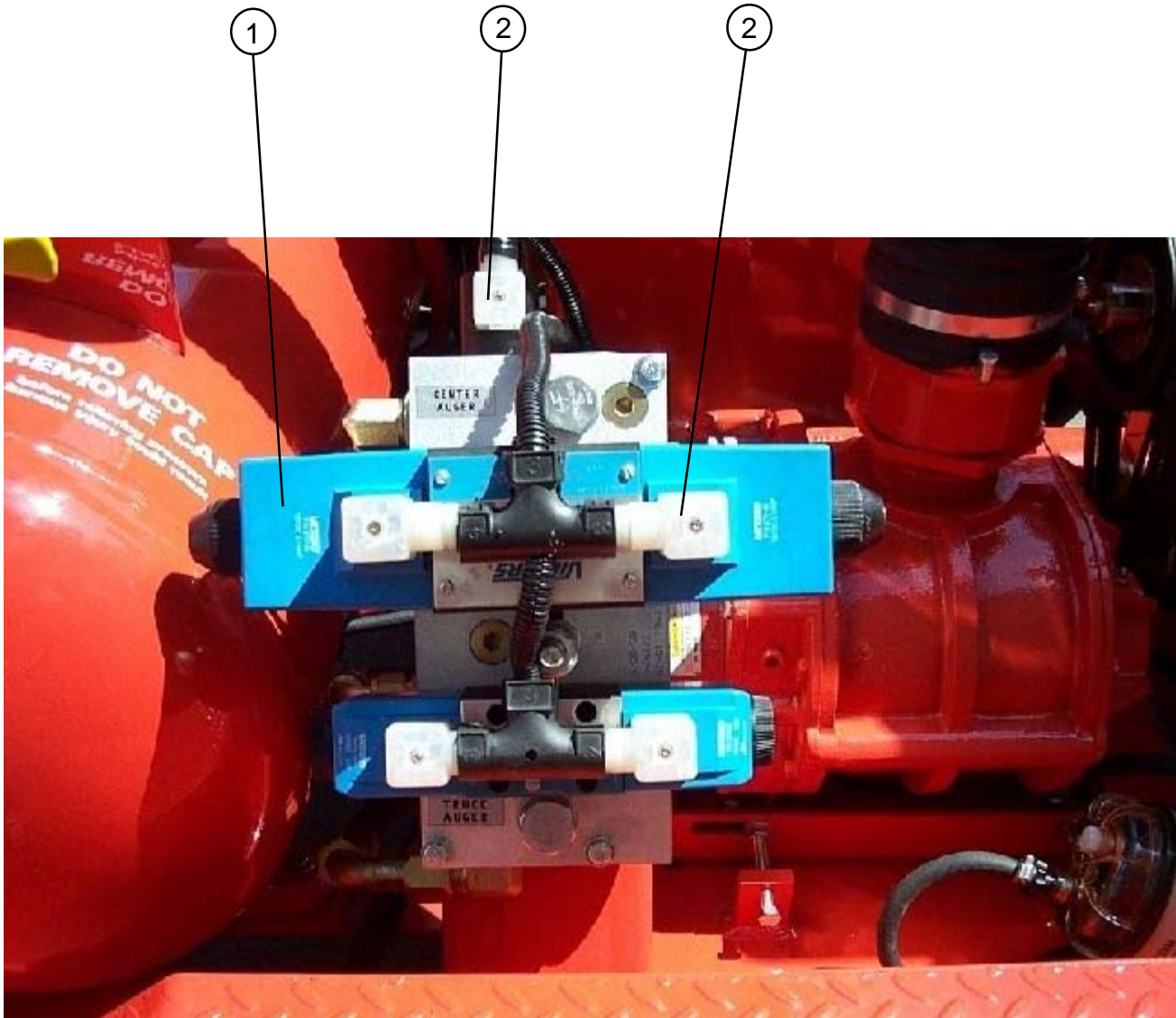

NUMBER	PART NUMBER	QTY	DESCRIPTION
1	92300	1	ALUMINUM HYDRAULIC CIRCUIT MANIFOLD ASSEMBLY
2	43474	5	O RING PLUG

DECAL-TOWING OF THE SPRAY INJECTION PATCHER



1

NUMBER	PART NUMBER	QTY	DESCRIPTION
1	90290	1	DECAL-TOWING SPRAY INJECTION PATCHER

ELECTRIC THROTTLE-REMOTE CONTROL/ACTUATOR

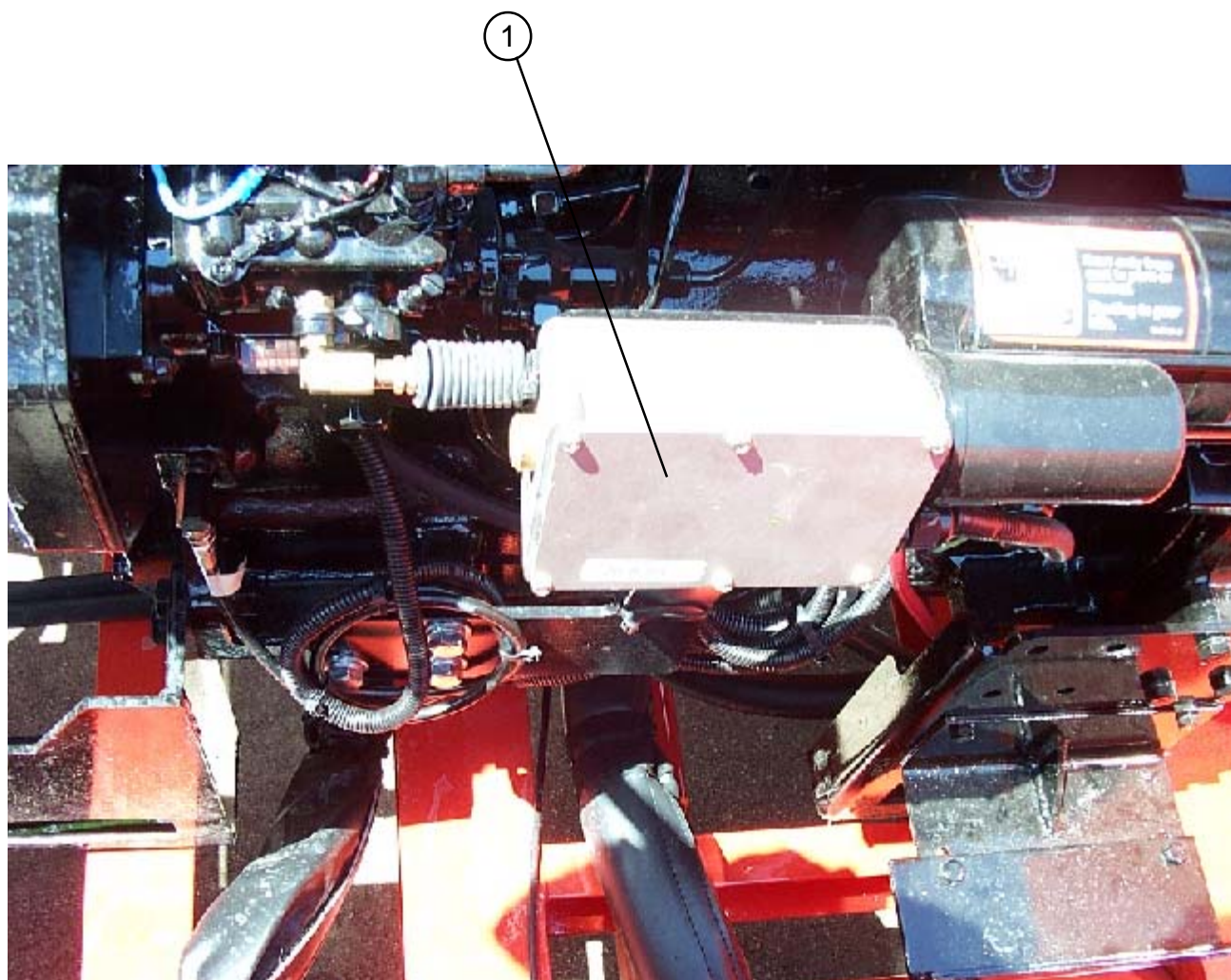

NUMBER	PART NUMBER	QTY	DESCRIPTION
1	91021K	1	ELECTRIC REMOTE CONTROL/ACTUATOR

OPERATOR BOOM AND HOSE

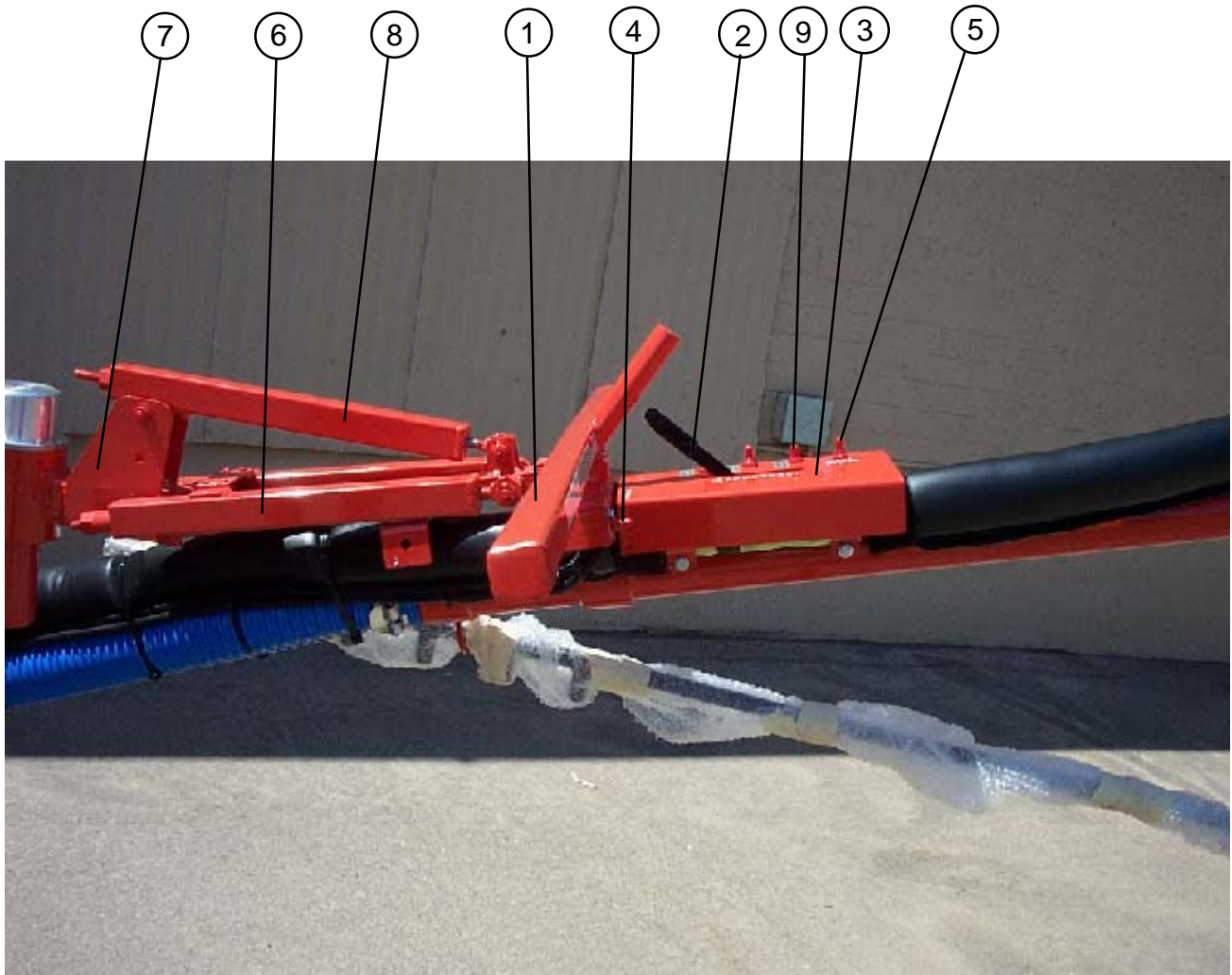

NUMBER	PART NUMBER	QTY	DESCRIPTION
1	91396	1	HANDLE ASSEMBLY
2	91700	1	EMULSION REGULATION VALVE ASSEMBLY
3	91230	1	COMPLETE ASSEMBLY CONTROL CONSOLE
4	91046	1	THROTTLE CABLE
5	50719	1	HORN SWITCH
6	91170	1	SPRING CYLINDER COMPLETE
7	91320	1	BEARING/RACE WELD BUSHING PIVOT ARM ASSEMBLY
8	91169	1	UPPER SPRING CYLINDER COMPLETE
9	32513	1	STONE SWITCH

OPERATOR BOOM AND HOSE

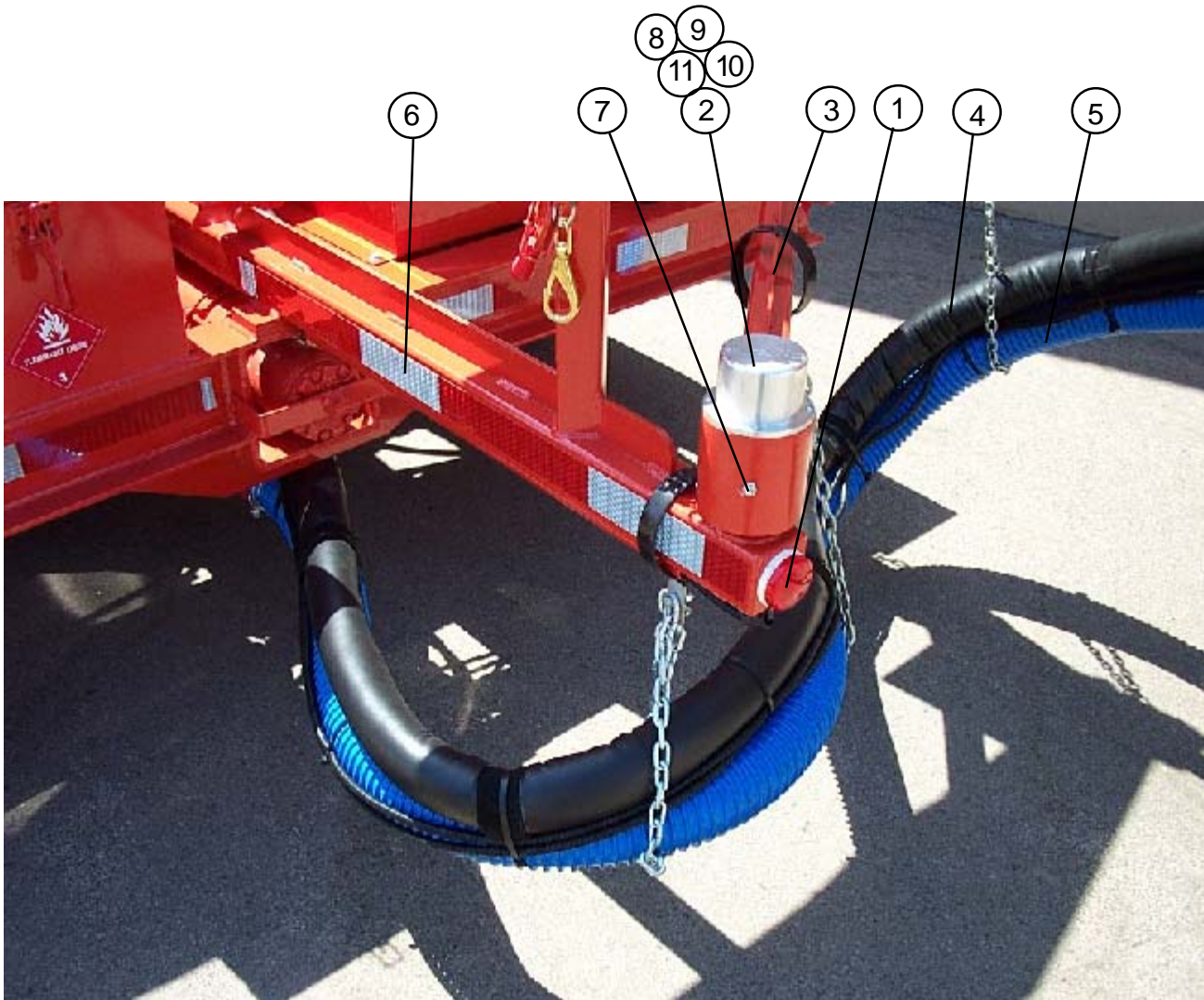

NUMBER	PART NUMBER	QTY	DESCRIPTION
1	91761	1	SMALL CYCLOPS TAIL LIGHT
2	90661	1	3" I.D. BEARING COVER
3	91535	1	1st BOOM SECTION
4	90304	1	EMULSION LINE COVER 15'-3" - MAG.
5	91157	13'-3"	3" BULK-AGGREGATE HOSE-BLUE
6	91310	1	BOOM MOUNTING SECTION
7	302026	1	1/8" NPT GREASE ZERK
8	90577	1	LARGE TAPER BEARING RACE
9	90576	1	LARGE TAPER BEARING
10	91722	1	LARGE CRENELLATED NUT
11	90581	1	LARGE OIL SEAL

TAIL LIGHT AND LICENSE BRACKET



NUMBER	PART NUMBER	QTY	DESCRIPTION
1	24023	1	TAIL LIGHT-LEFT SIDE
2	90544	1	LICENSE BRACKET WITH LIGHT
3	24128	1	RED CLEARANCE LIGHT
4	24022	1	TAIL LIGHT-RIGHT SIDE

JOHN DEERE ENGINE CONTROL PANEL



JOHN DEERE ENGINE CONTROL PANEL

NUMBER	PART NUMBER	QTY	DESCRIPTION
1	51695	1	CIRCUIT BREAKER 30 AMPS
2	50238	1	JUMPER
3	51694	1	CIRCUIT BREAKER 5 AMPS
4	91764	1	TEMPERATURE SWITCH GAUGE
5	91822	1	AMP METER
6	90537	1	SWTCH KEY
7	91854	1	TACHOMETER WITH HOUR METER
8	91780	1	HOUR METER
9	91837	1	COOLANT PRESSURE SWITCH GAUGE
10	91758	1	MAGNETIC SWITCH
11	91846	1	ENCLOSURE ASSEMBLY
12	91847	1	BACK PANEL
13	91869	1	OIL PRESSURE SWITCH GAUGE
14	91177	1	FUSE HOLDER
15	91032	1	CONTROL PANEL-PURCHASED COMPLETE
16	90453	1	2" 0-300 HYD PRESSURE GAUGE
17	90625	1	ARROW BOARD & CONTROL BOX
18	91032	1	ENGINE CONTROL PANEL - PURCHASED

ARROWBOARD CONTROLLER PROTECTION BOX



NUMBER	PART NUMBER	QTY	DESCRIPTION
1	91032	1	ENGINE CONTROL PANEL - PURCHASED
2	90395	1	ARROWBOARD C ONTROLLER PROTECTION BOX
3	90626	1	ARROWBOARD C ONTROL BOX - REPLACEMENT BOX

ARROWBOARD & CONTROL BOX ASSEMBLY



NUMBER	PART NUMBER	QTY	DESCRIPTION
1	90624	1	ARROW BOARD & CONTROL BOX ASSY.
2	90797	4	LIGHT BRACKET SUPPORT ANGLE

BOLT-ON ENGINE COMPRESSOR AND COMPONENTS



NUMBER	PART NUMBER	QTY	DESCRIPTION
1	50109	1	FILTER AIR COMPRESSOR
2	90899	1	GOVERNOR - COMPRESSOR UNLOADING MECHANICAL
3	41403	1	1/2" STAINLESS STEEL LINE
4	91022	1	ENGINE BOLT-ON 13 CFM COMPRESSOR - JOHN DEERE ENGINE
5	90890	1	INTAKE AIR COMPRESSOR FILTER BRACKET
6	90861	1	INTAKE AIR COMPRESSOR HOSE

ON-BOARD COMPRESSOR VALVE ASSEMBLY

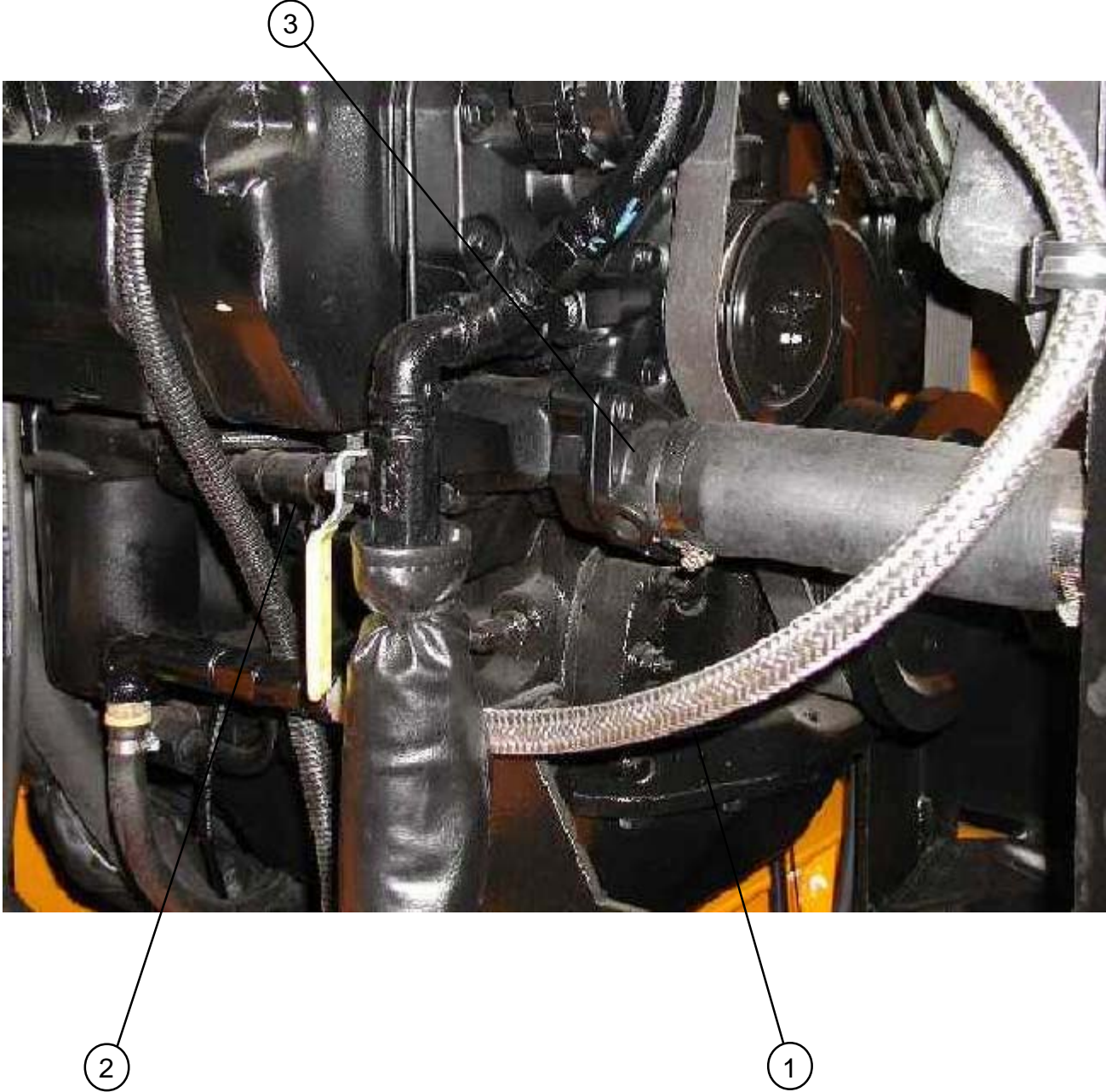

NUMBER	PART NUMBER	QTY	DESCRIPTION
1	41403	1	1/2" STAINLESS STEEL LINE
2	90895	1	ON-BOARD COMPRESSOR VALVE ASSEMBLY
3	90530	1	WATER PUMP OUTLET HEATING VALVE ASSEMBLY

EMULSION TANK GAUGE HOLDER



NUMBER	PART NUMBER	QTY	DESCRIPTION
1	91830	1	EMULSION TANK GAUGE DIPSTICK
2	90235	1	DIPSTICK HEIGHT GAUGE HOLDER

EMULSION TANK GAUGE



NUMBER	PART NUMBER	QTY	DESCRIPTION
1	91830	1	EMULSION TANK GAUGE DIPSTICK (REF. SEE DECAL ON FRONT OF EMULSION TANK)

HYDRAULIC TAILGATE ASSEMBLY (91196K)



NUMBER	PART NUMBER	QTY	DESCRIPTION
1	90650	1	SHORT ROCK CHUTE
2	90752	1	ROCK CHUTE COVER

HYDRAULIC TAILGATE ASSEMBLY (91196K FOR KIT)

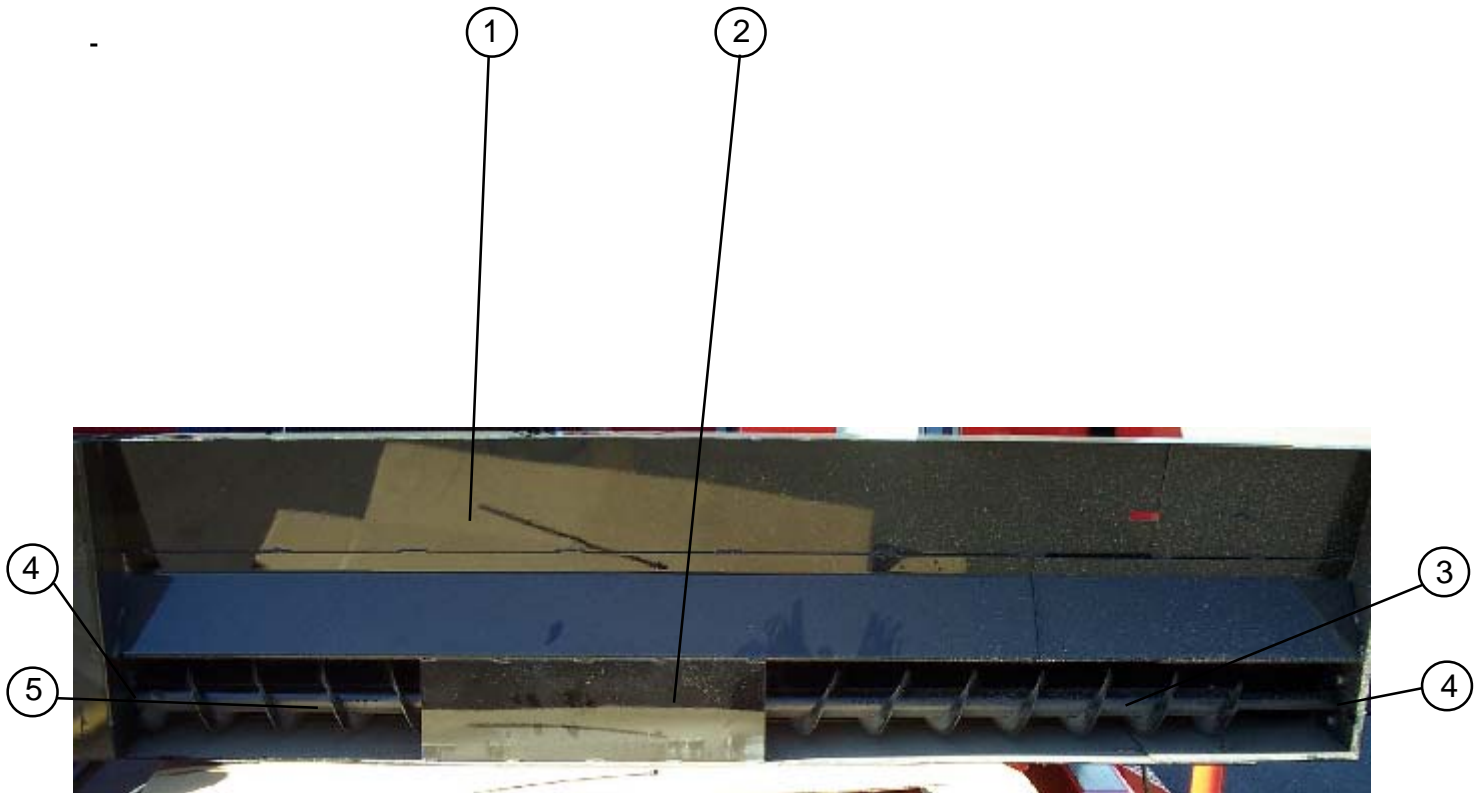

NUMBER	PART NUMBER	QTY	DESCRIPTION
1	91195	1	TRUCK AUGER TAILGATE
2	90613	1	SCREW AUGER SHAFT WITH PADDLES (NOT SHOWN)
3	90614	1	LONG SCREW AUGER
4	90578	2	TRUCK AUGER BEARING 2-BOLT FLANGE
5	90611	1	SHORT SCREW AUGER

HYDRAULIC TAILGATE ASSEMBLY (91196K)

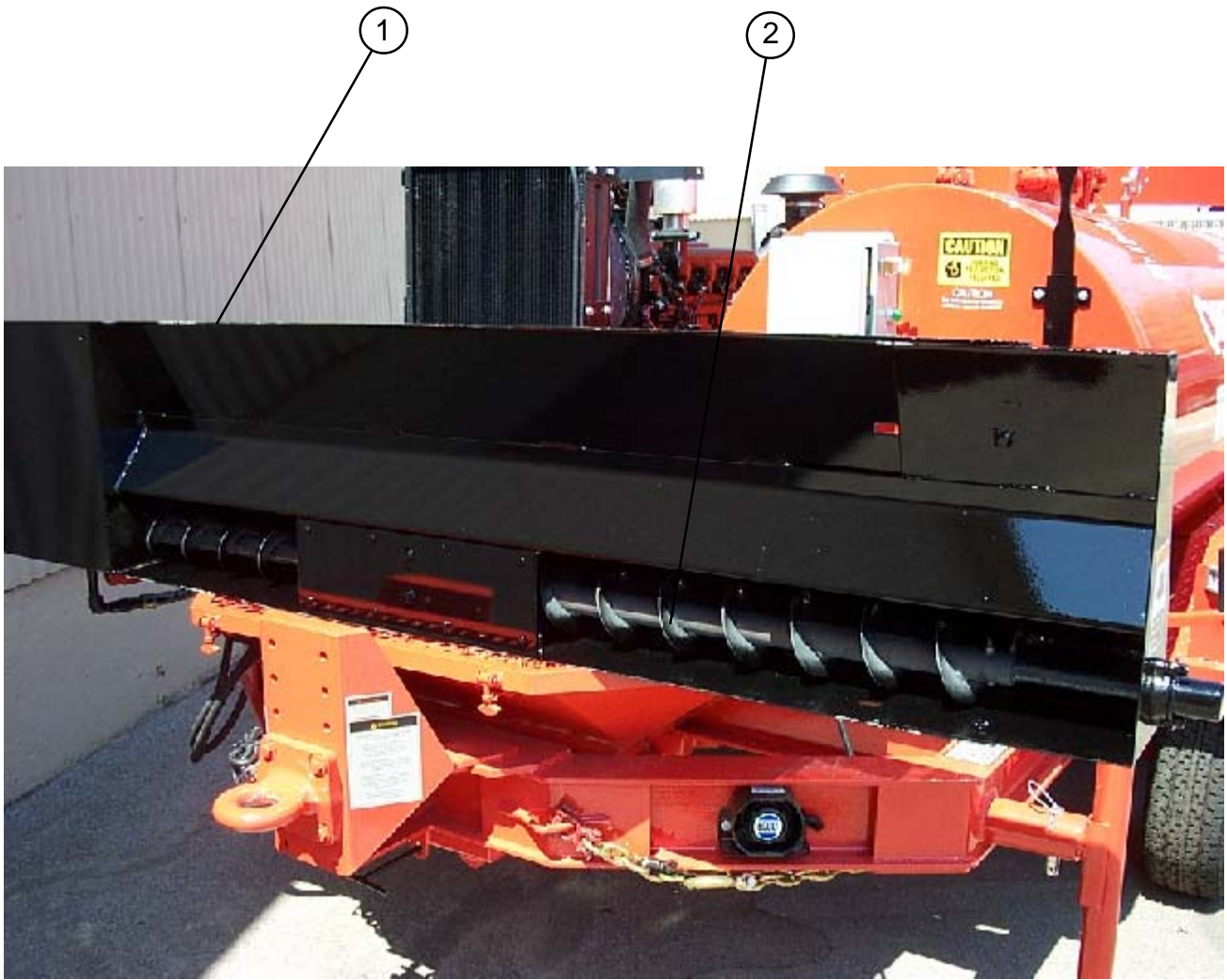

NUMBER	PART NUMBER	QTY	DESCRIPTION
1	91196K	1	TAILGATE KIT
2	90614	1	LONG SCREW AUGER

HYDRAULIC TAILGATE ASSEMBLY (91196K)

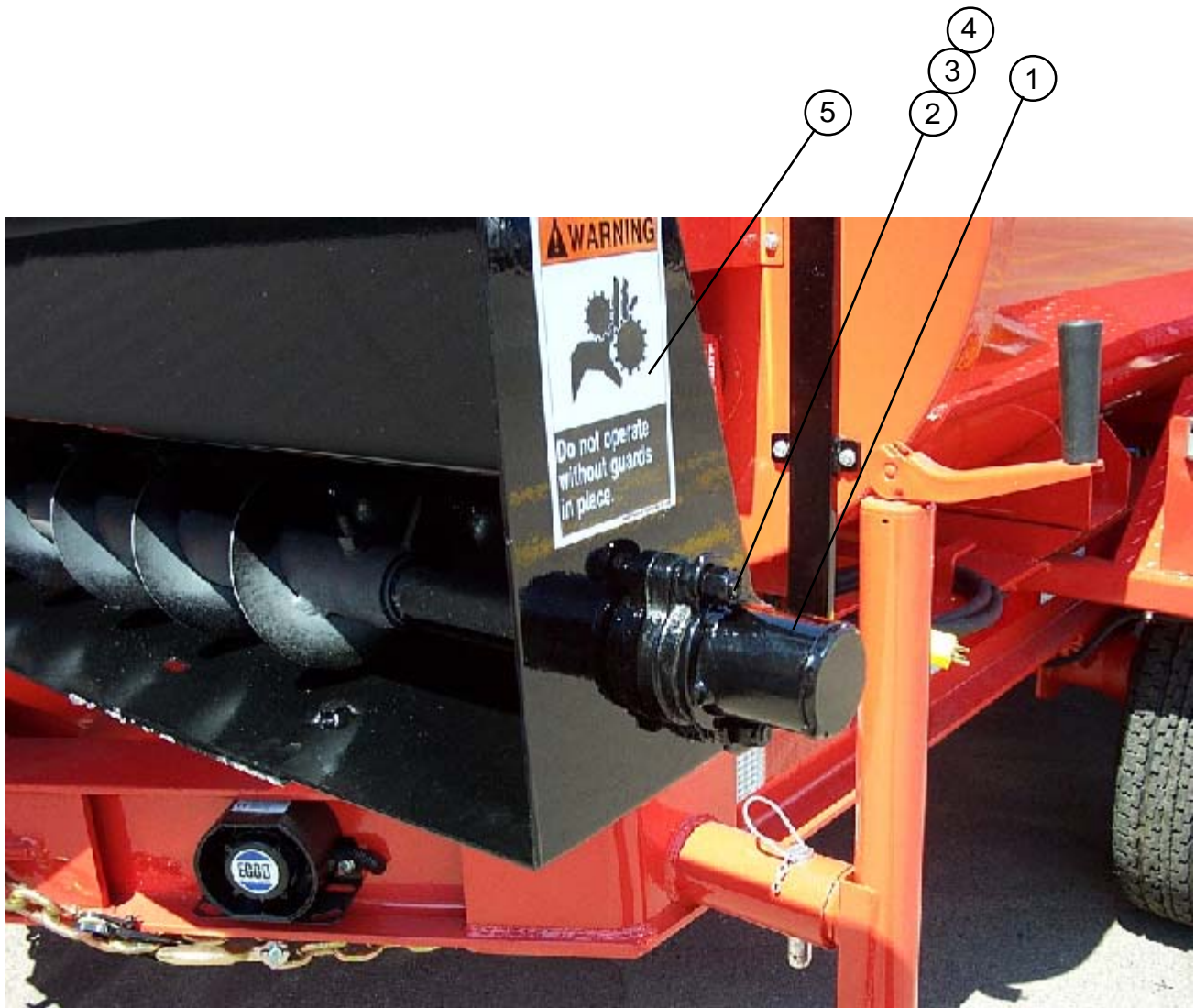

NUMBER	PART NUMBER	QTY	DESCRIPTION
1	28672	2	3/8 FLAT WASHER
2	28502	2	3/8-16 NC HEX NUT
3	28734	2	3/8-16 X 1-3/4 HEX HEAD BOLT
4	90288	2	DECALWARNING DO NOT OPERATE W/O

HYDRAULIC TAILGATE ASSEMBLY (91196K)

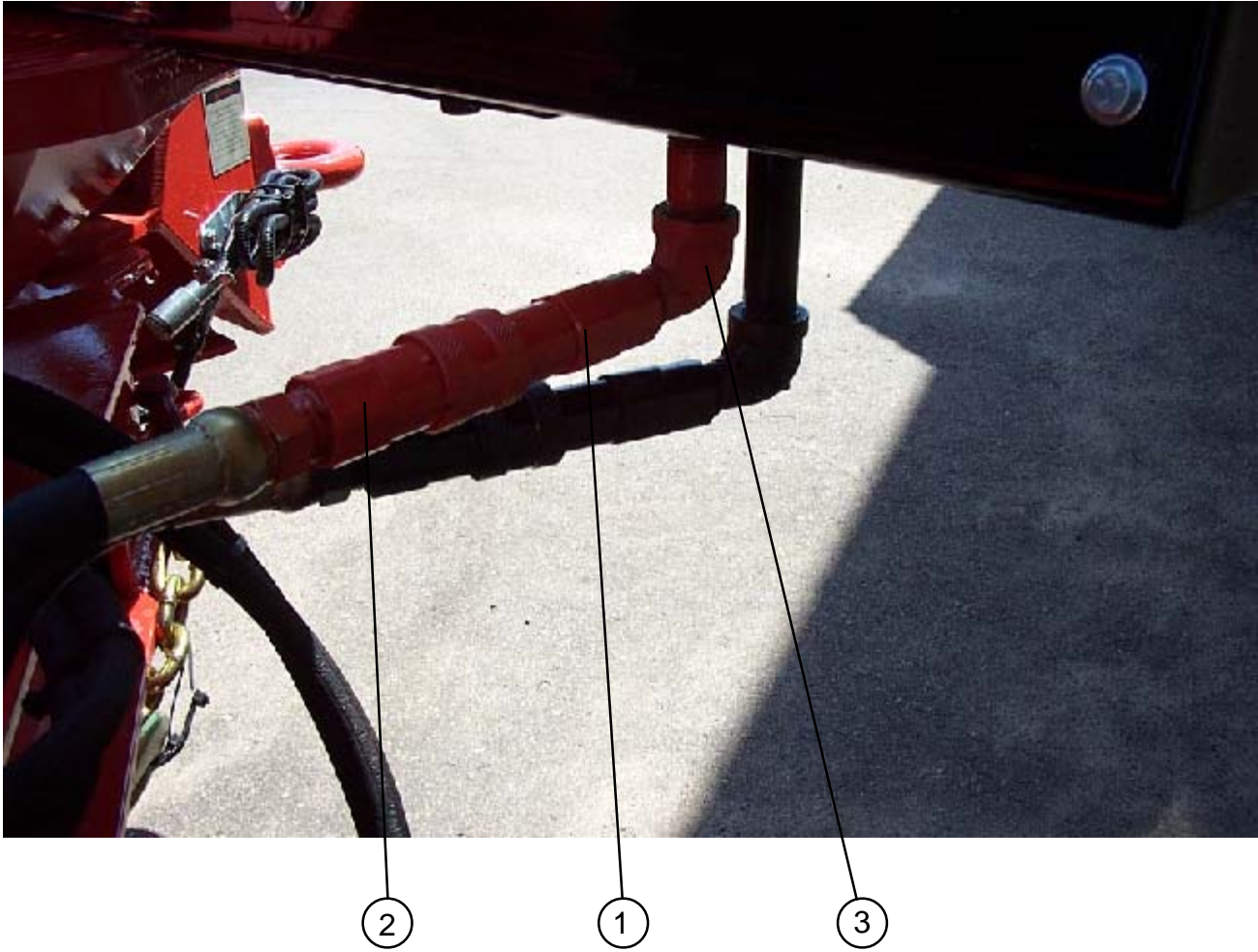

NUMBER	PART NUMBER	QTY	DESCRIPTION
1	91243	2	1/2 HOLMBURY PLUG
2	91244	2	1/2 HOLMBURY SOCKET
3	28238	2	1/2 STREET ELBOW

HYDRAULIC TAILGATE ASSEMBLY (91196K)

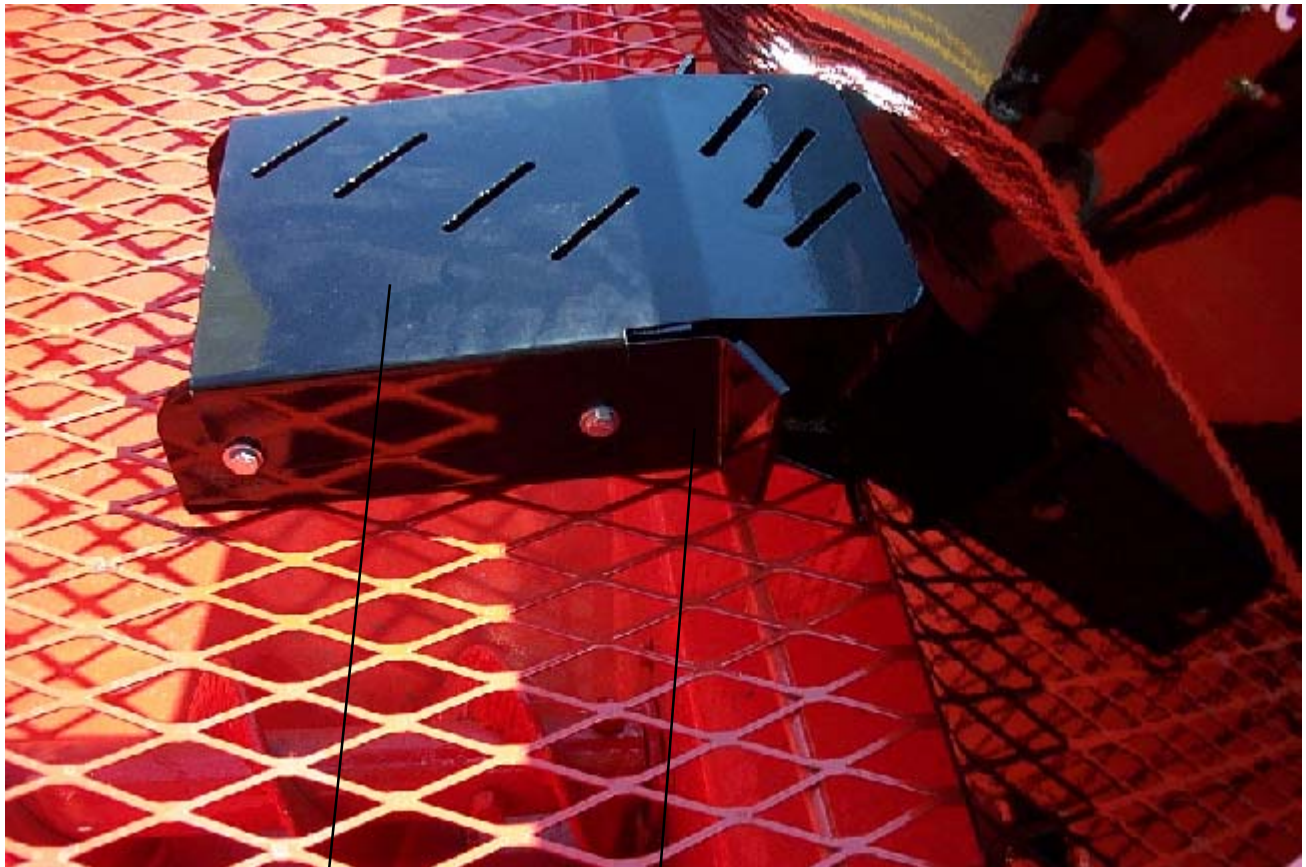

2

1

NUMBER	PART NUMBER	QTY	DESCRIPTION
1	90650	1	SHORT ROCK CHUTE
2	90752	1	ROCK CHUTE COVER

2-1/2" I.D. FRONT PINTLE HITCH

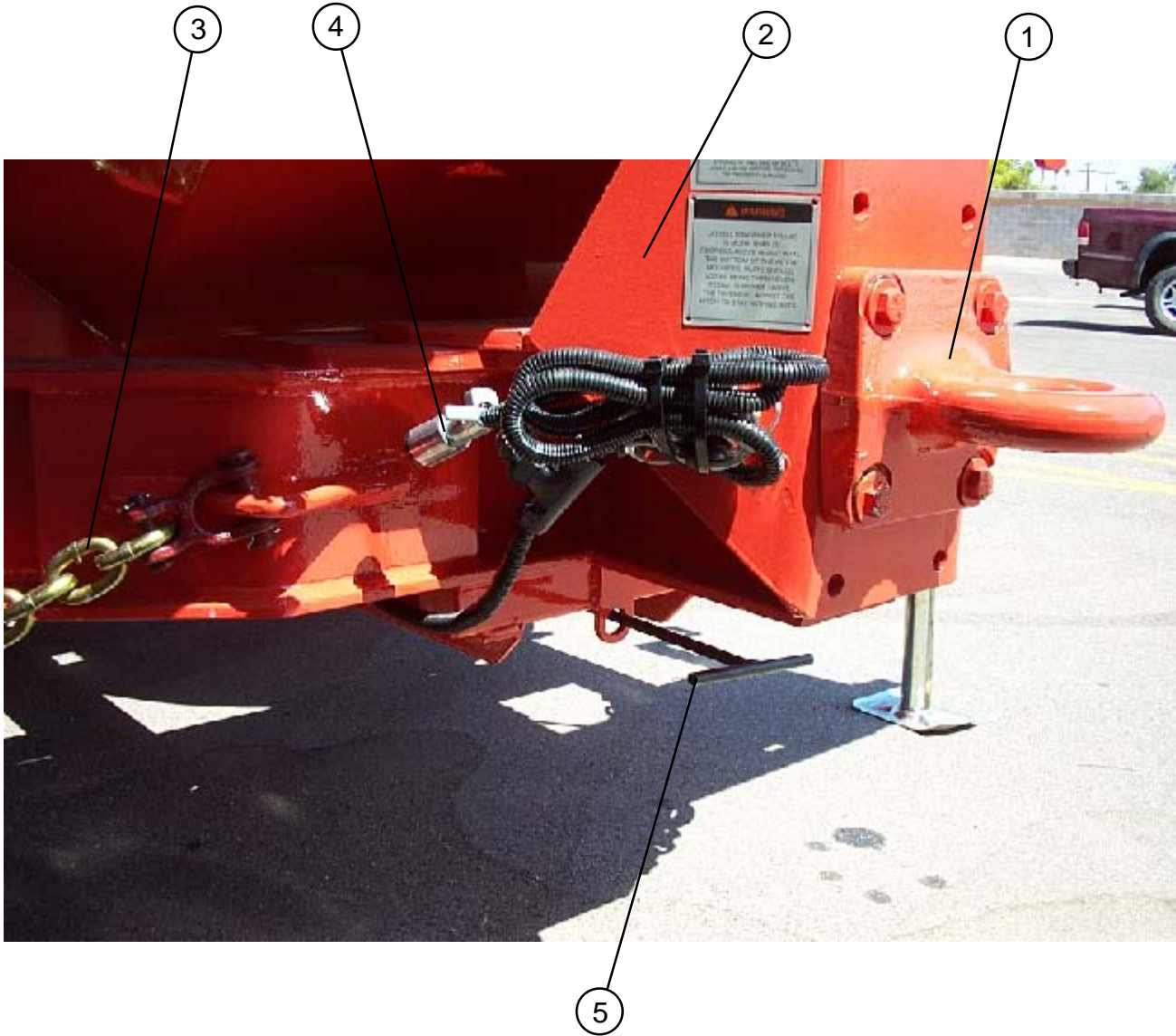

NUMBER	PART NUMBER	QTY	DESCRIPTION
1	91850	1	2-1/2" ID EYE DROP FROGED STL DRB
2	90735	1	FRONT HITCH PLATE ASSEMBLY
3	90514	2	3/8" SAFETY CHAIN HOOK
4	24074	1	6 WIRE TRAILER CONNECTOR
5	91276	1	HOPPER DUMP DOOR PULL BAR

REAR BOOM SADDLE



2

3

1

NUMBER	PART NUMBER	QTY	DESCRIPTION
1	91290	1	REAR COBRA SADDLE HOLDER
2	91648	1	BOOM STOW SAFETY CHAIN
3	32026	1	1/8 NPT GREASE ZERK

SPRING ARM ASSEMBLY



3

2

1

NUMBER	PART NUMBER	QTY	DESCRIPTION
1	91184	1	SPRING CYLINDER ASSEMBLY R.H.
2	91170	1	SPRING CYLINDER ASSEMBLY L.H.
3	91169	1	UPPER SPRING CYLINDER ASSEMBLY

CONTROL CONSOLE

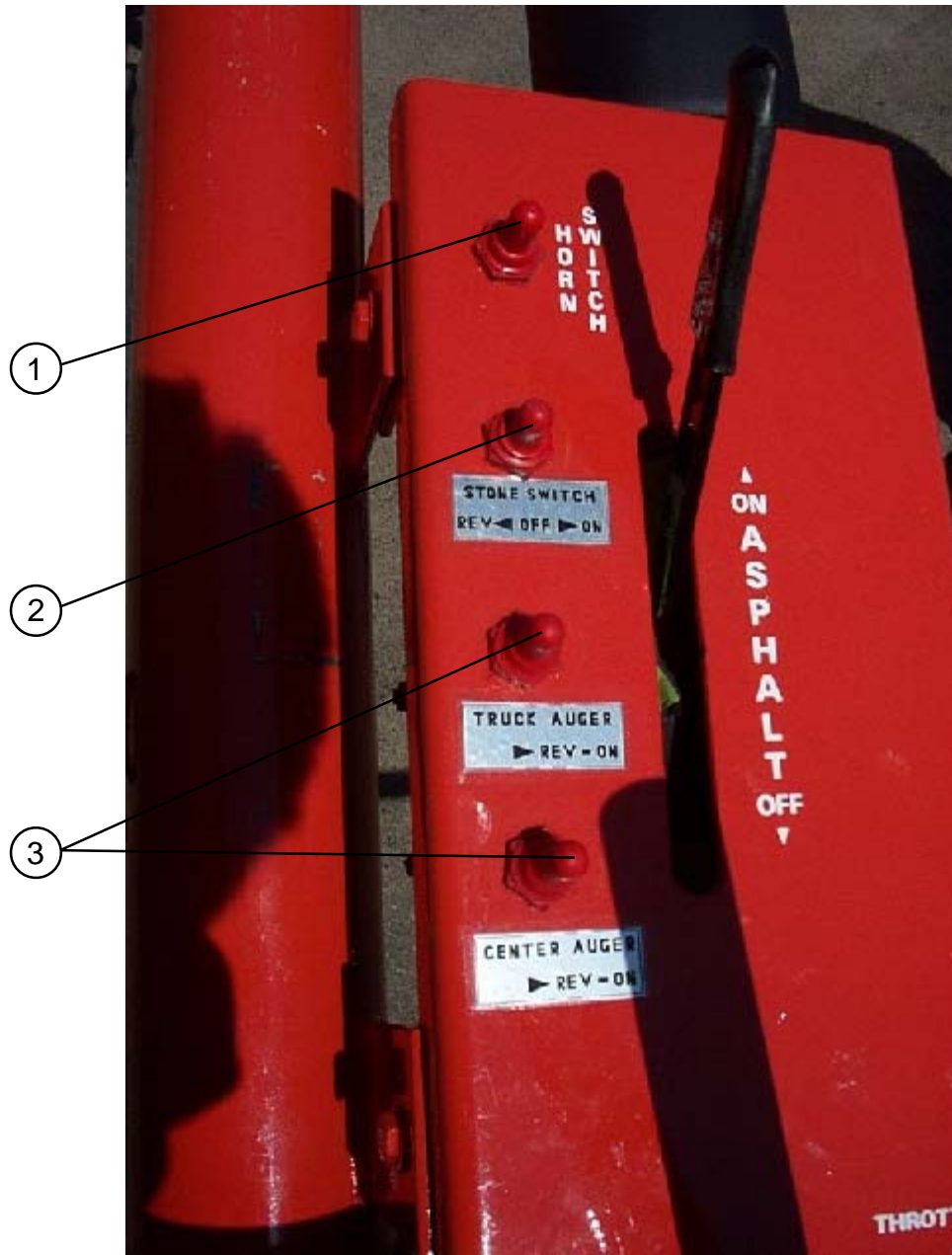

NUMBER	PART NUMBER	QTY	DESCRIPTION
1	50719	1	TOGGLE SWITCH
2	32580	1	TOGGLE SWITCH DPDT/ON-OFF-ON
3	51678	2	SWITCH SPDT

ARMORED CLEARANCE LIGHT



1

2

NUMBER	PART NUMBER	QTY	DESCRIPTION
1	90546	2	ARMORED CLEARANCE LIGHT
2	90547	2	3" ROUND AMBER REFLECTOR

SILENCER



4

2

3

1

5

NUMBER	PART NUMBER	QTY	DESCRIPTION
1	28010	1	3" CLOSED NIPPLE
2	28259	1	3" X 2" X 3" PIPE TEE
3	28288	1	2" PIPE PLUG
4	60116	1	SILENCER
5	28200	1	3" 45 DEGREE THREADED ELBOW

BLOWER PRESSURE RELIEF VALVE



4

3

1

2

NUMBER	PART NUMBER	QTY	DESCRIPTION
1	28010	1	3" CLOSED NIPPLE
2	91668	1	3" X 2" X 3" PIPE TEE DRILLED
3	28008	1	2" CLOSED NIPPLE
4	91250	1	BLOWER PRESS RELIEF VALVE 7 PSI

WATER/FUEL SEPARATOR



NUMBER	PART NUMBER	QTY	DESCRIPTION
1	90420	1	WATER/FUEL SEPARATOR J.D. ENGINE 4045D COMPLETE

8 FOOT QUICK FLUSH HOSE-OPTION

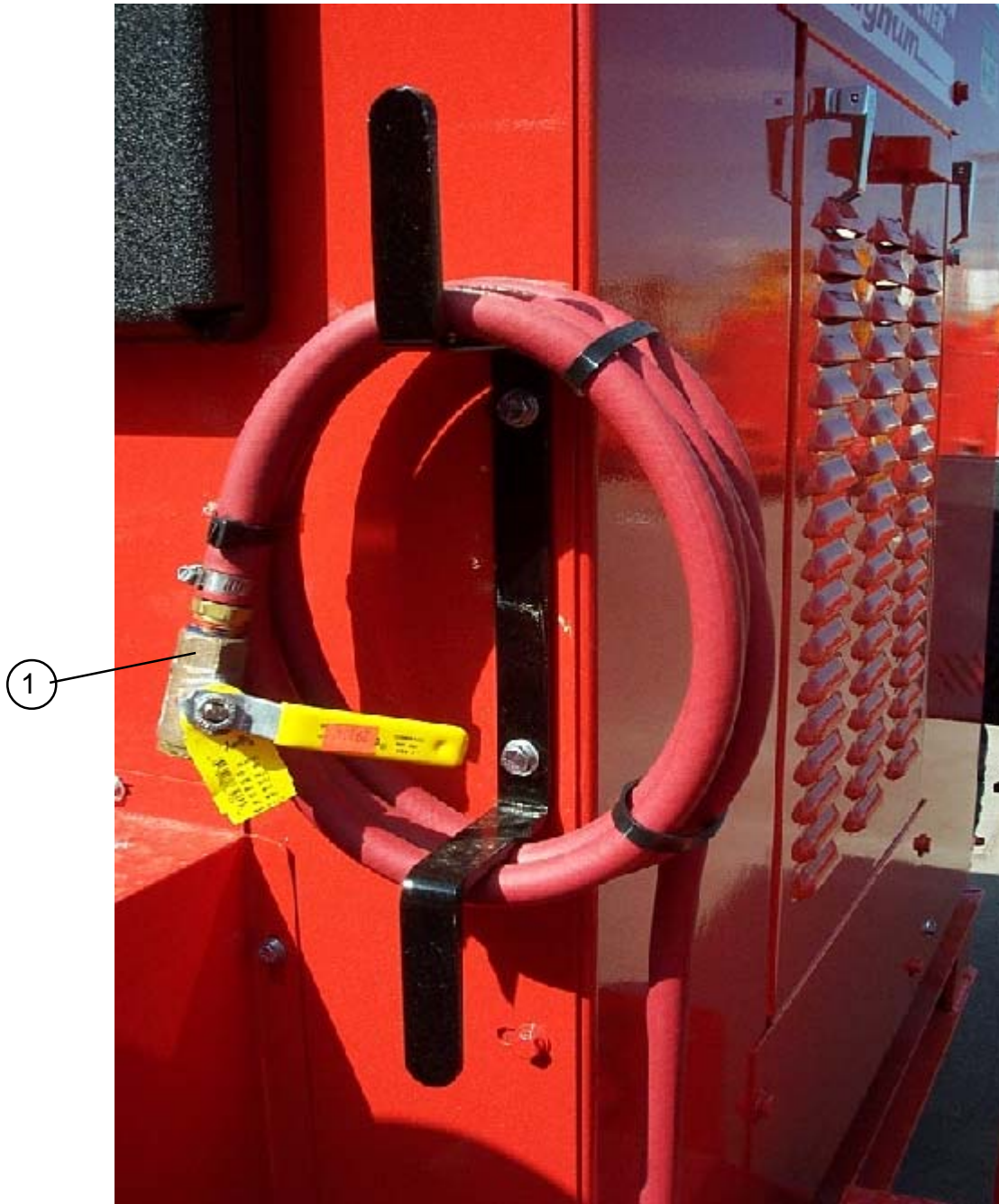

NUMBER	PART NUMBER	QTY	DESCRIPTION
1	90225	1	8 FOOT QUICK FLUSH HOSE-OPTION

MANUAL BOX



NUMBER	PART NUMBER	QTY	DESCRIPTION
1	25289	1	MODEL 550 MANUAL BOX
2	91285	1	MAGNUM PARTS MANUAL (NOT SHOWN)

INLET HOOD-AIR CLEANER



NUMBER	PART NUMBER	QTY	DESCRIPTION
1	91029	1	INLET HOOD- SMALL HOOD-J.D. ENGINE

3" ROUND RED REFLECTOR

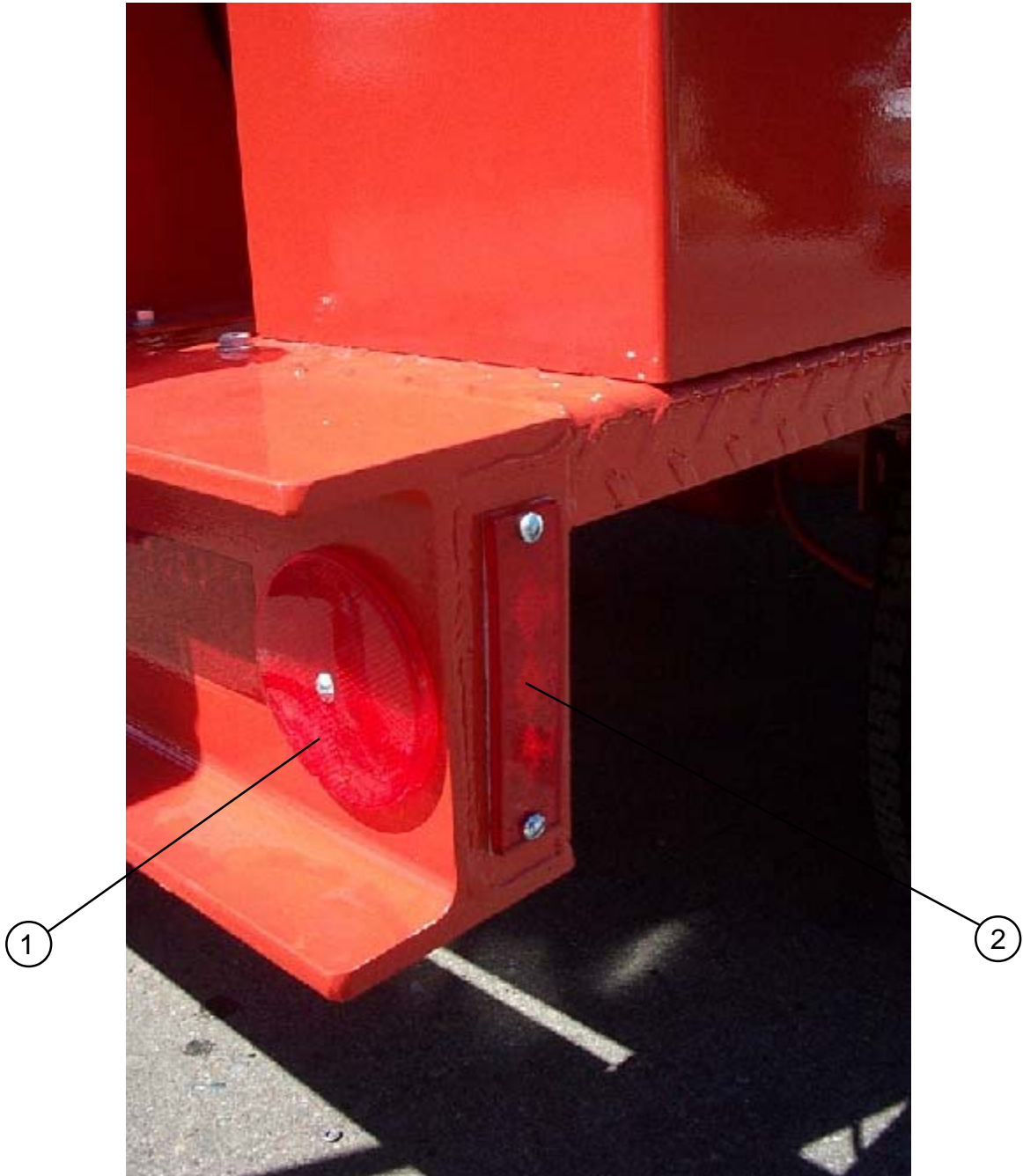

NUMBER	PART NUMBER	QTY	DESCRIPTION
1	90549	1	3" ROUND REFLEX REFLECTOR
2	91299	1	RECTANGLE RED REFLECTOR

EMULSION TANK DRAIN VALVE ASSEMBLY

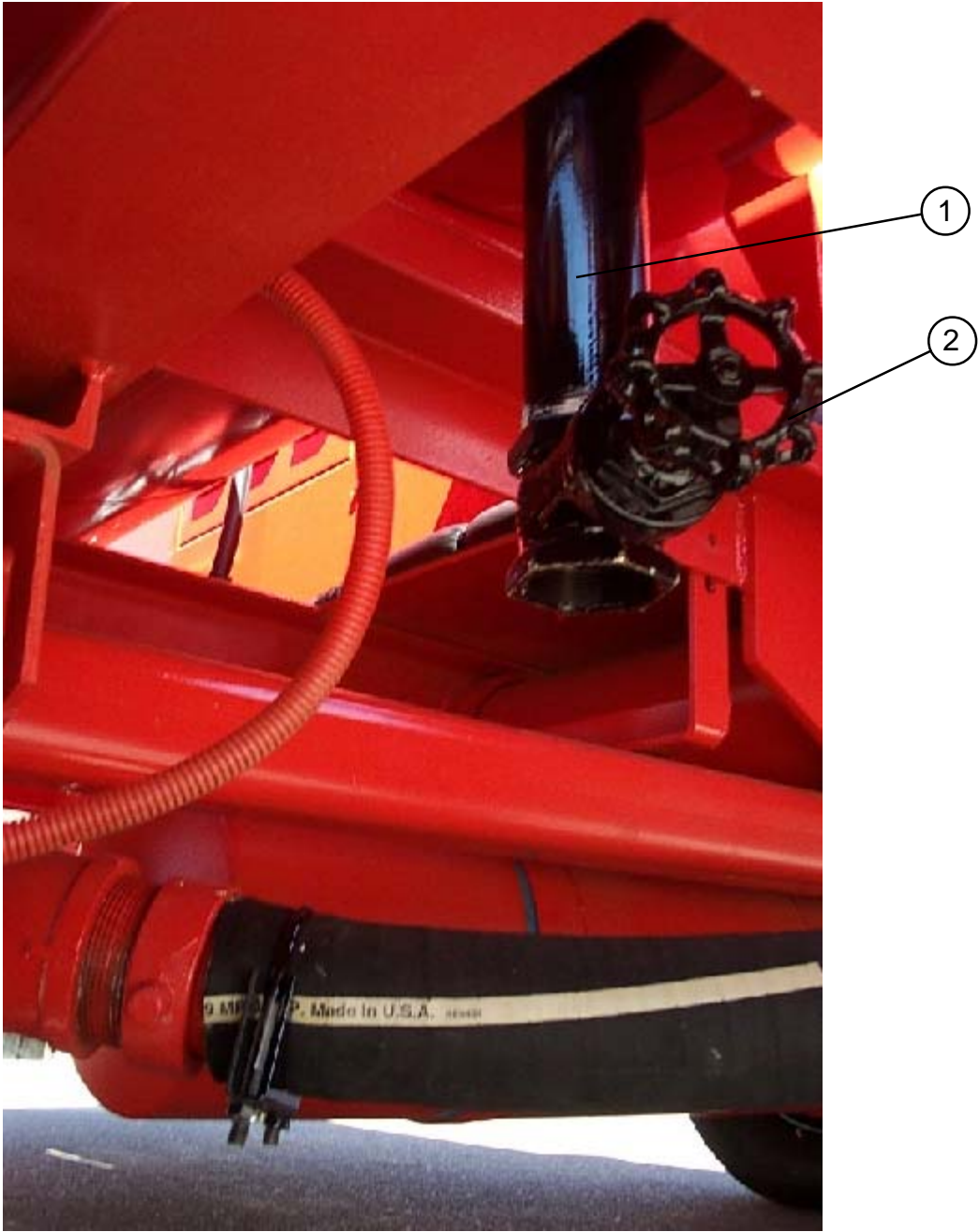

NUMBER	PART NUMBER	QTY	DESCRIPTION
1	28136	1	2" NIPPLE X 9" LONG THREADED BOTH
2	29270	1	BRONZE GATE VALVE 2"

MAGNUM COBRA BOOM ARM ASSEMBLY PART NUMBERS

NUMBER	PART NUMBER	QTY	DESCRIPTION
1	91073	1	3" PIPE WELDING ASSEMBLY
2	91225	1	MAGNUM SPRING ARM ASSEMBLY
3	91545	1	BOOM SECTION 2ND C COMPLETE
4	91535	1	1ST BOOM SECTION
5	91310	1	BOOM MOUNT SECTION
6	90661	2	3" ID BEARING COVER
7	28702	2	1/4" X 1" HEX HEAD BOLT
8	28670	4	1/4" FLAT WASHER
9	28524	2	1/4" ESNA LOCK NUT
10	32513	1	TOGGLE SWITCH
11	91723	2	SWITCH COVER BOOT
12	50719	1	TOGGLE SWITCH
13	32513	1	TOGGLE SWITCH
14	91396	1	HANDLE ASSEMBLY
15	91359	1	2ND SECT SUPT ASSEMBLY
16	91700	1	ENULSIN REGULATION VALVE
17	25952	1	3-1/2" MUFFLER CLAMP
18	90576	6	LARGE TAPER BEARING
19	90577	6	LARGE TAPER BEARING RACE
20	91722	3	LARGE CRENELLATED NUT
21	90581	3	LARGE OIL SEAL
22	91220	1	3" BOX 45 DEGREE ELBOW
23	91230	1	C COMPLETE ASSEMBLY C CONTROL C CONSOLE
24	91005	1	MAGNUM FRAME
25	90508	1	LARGE GREASE CAP-STEEL

MAGNUM COBRA BOOM ARM ASSEMBLY PART NUMBERS

NUMBER	PART NUMBER	QTY	DESCRIPTION
26	29641	3	1/8" x 2-1/2" COTTER PIN
27	32026	3	1/8" NPT GREASE ZERK
28	28634	4	3/8" FLAT WASHER
29	28630	12	#8 STAR LOCK WASHER
30	28826	12	#8-32 X 1/2" ROUND HEAD SCREW
31	28732	2	3/8" 1-1/4 HEX HEAD BOLT
32	28526	2	3/8" ESNA LOCK NUT
33	37032	1	1/4" X 1-1/8" KEY
34	91312	1	AGGREGATE BOOM CLAMP ASSEMBLY

MAGNUM NOZZLE DISCHARGE ASSEMBLY PART NUMBERS

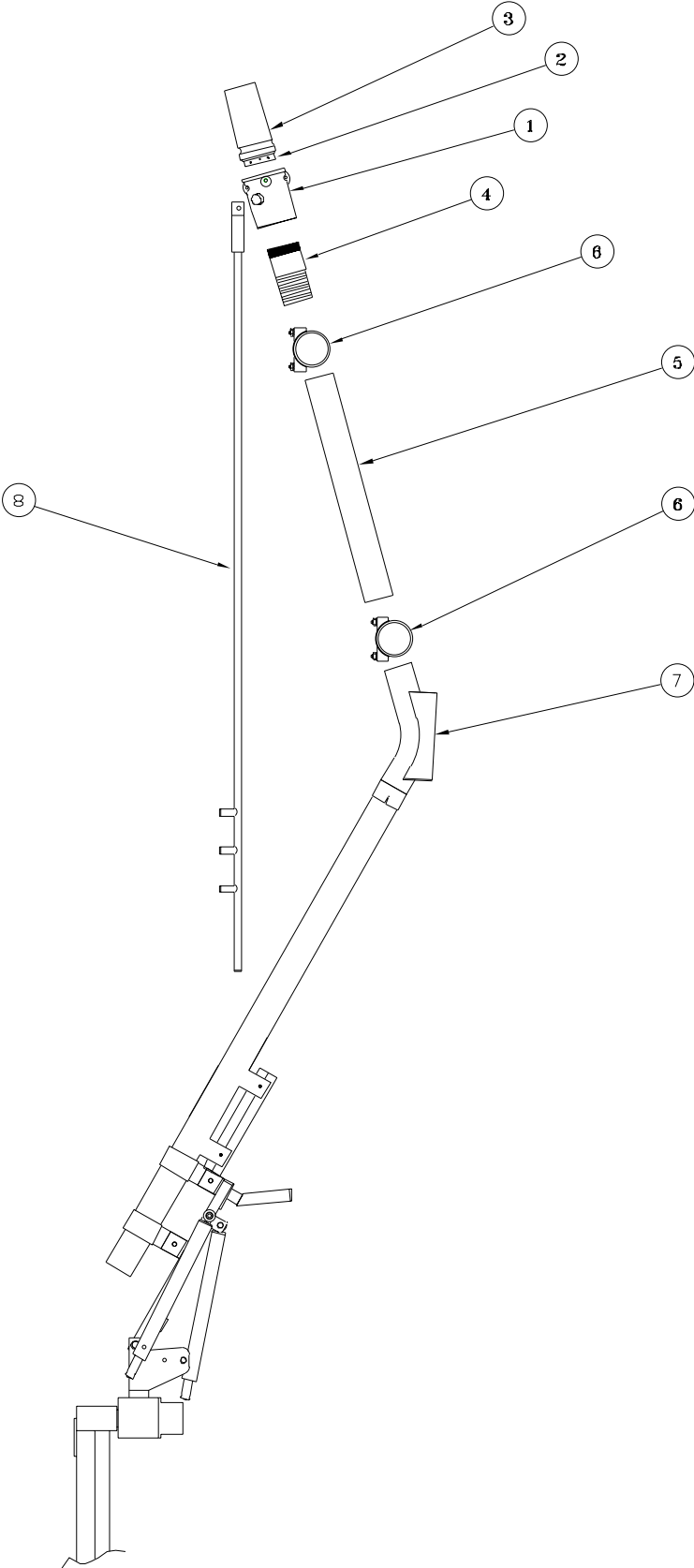

MAGNUM NOZZLE DISCHARGE ASSEMBLY PART NUMBERS

NUMBER	PART NUMBER	QTY	DESCRIPTION
1	91103	1	3" ALUMINUM NOZZLE HOUSING
2	91099	1	3" O-RING
3	91100	1	NOZZLE WITH SPRAY RING ATTACHED
4	91344	1	3" KING NIPPLE
5	91346	1	3" X 20" GUM RUBBER HOSE
6	91855	2	HOSE CLAMP 3" TIGER
7	91220	1	3" BOXED 45° ELBOW
8	91162	1	NOZZLE POSITION HANDLE

MAGNUM REAR PASSENGER SIDE COMPONENTS PART NUMBERS

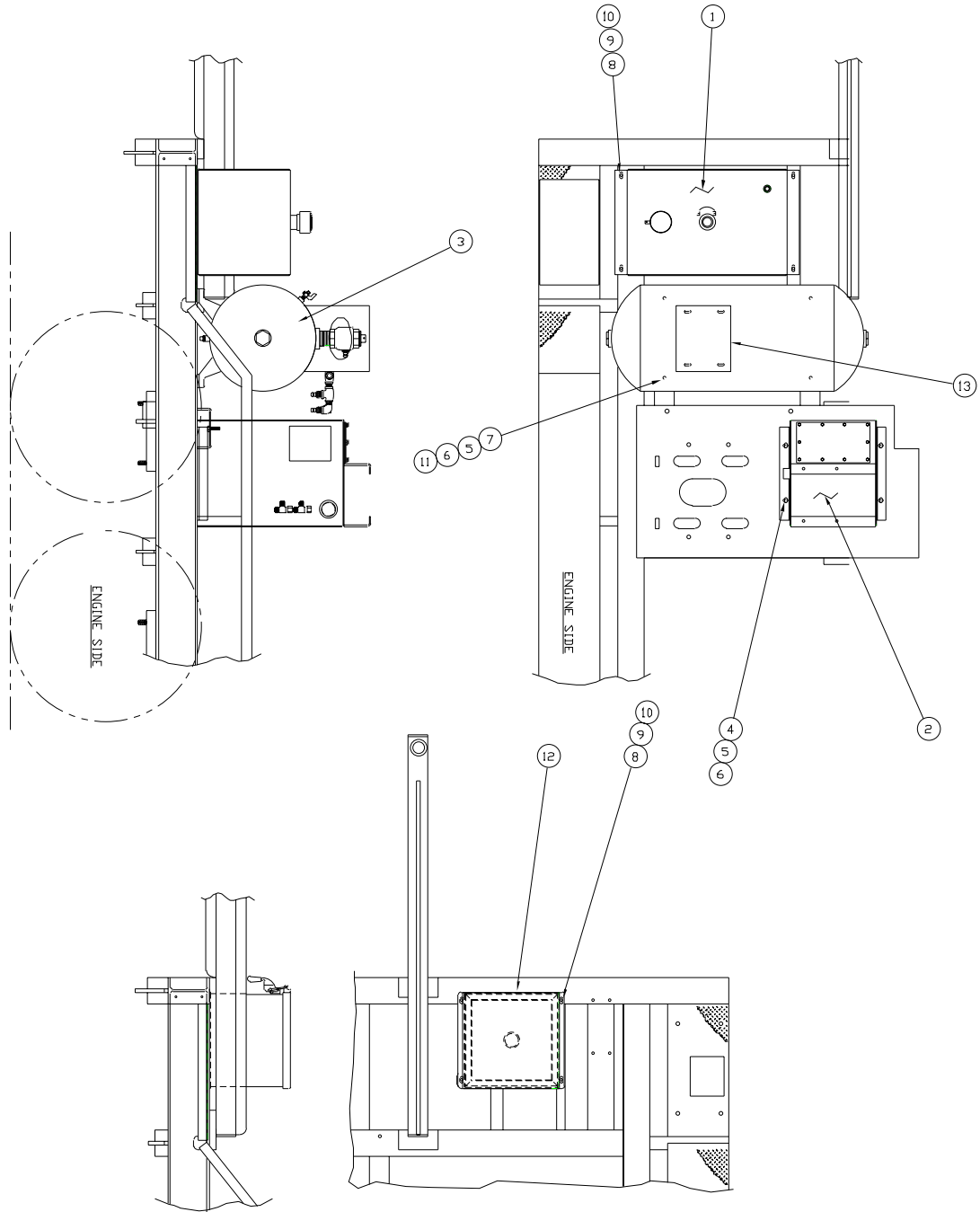

MAGNUM REAR PASSENGER SIDE COMPONENTS PART NUMBERS

NUMBER	PART NUMBER	QTY	DESCRIPTION
1	91510	1	FUEL TANK COMPLETE
2	90815	1	HYDRAULIC TANK COMP ASSEMBLY
3	90860	1	30 GAL. DIESEL FLUSH TANK
4	27954	4	3/8"-16 X 1-1/2" HEX HEAD BOLT
5	28526	8	3/8"-16 NC ESNA NYLON NUT
6	28641	8	3/8" FLATWASHER GRADE 8
7	28737	4	3/8"-16 X 3" HEX HEAD BOLT
8	28717	8	5/16"-18 X 1-1/4" HEX HEAD BOLT
9	28671	12	5/16" FLATWASHER
10	28646	8	5/16"-18 ESNA NYLON NUT
11	43876	4	MOUNTING PAD
12	91530	1	DEEP NOZZLE STORAGE BOX
13	91271	1	AIR CLEANER MOUNTING BRACKET

MAGNUM AIR DISCHARGE PLUMBING CIRCUIT PART NUMBERS

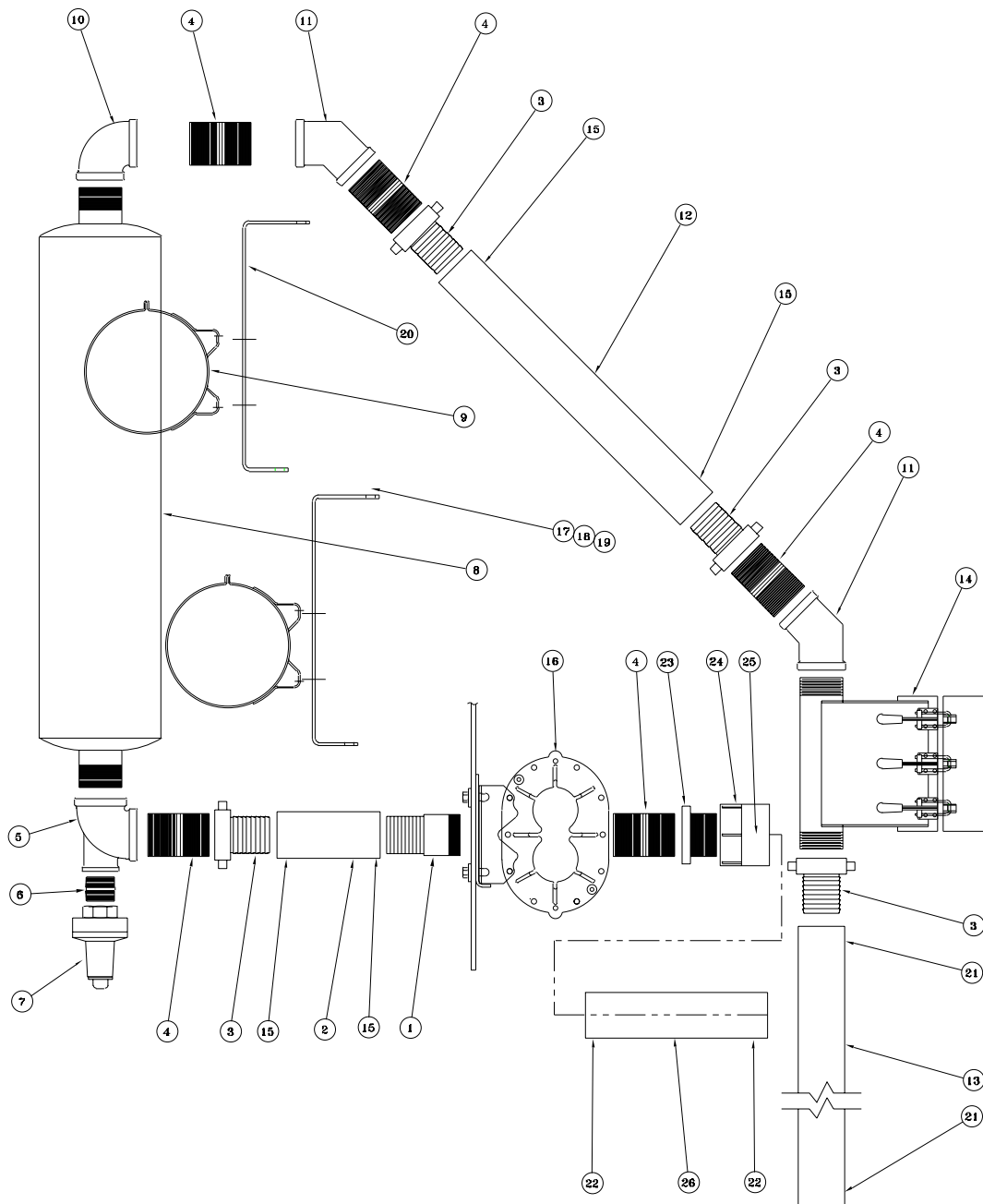

MAGNUM AIR DISCHARGE PLUMBING CIRCUIT PART NUMBERS

NUMBER	PART NUMBER	QTY	DESCRIPTION
1	91344	1	3" NIPPLE/HOSE COMBO KING
2	91339	1	3" WILDCAT HOSE X 8-1/2" LG.
3	90554	4	PIN PLUG/3" FEMALE COUPLER
4	28010	5	3" CLOSED NIPPLE
5	91668	1	3" X 2" X 3" BLACK MITEE-DRILLED
6	28008	1	CLOSED NIPPLE 2"
7	91250	1	BLOWER PRESS RELIEF VALVE - 7 PSI
8	60116	1	CHAMBER ABSORPTION SILENCER
9	91708	2	MOUNTING RING CLAMP
10	28215	1	3" 90 DEGREE PIPE ELBOW
11	28200	1	3" 45 DEGREE THREADED ELBOW
12	91338	1	3" WILDCAT HOSE X 28" LG
13	91157	13 ft.	3' BULK AGGREGATE HOSE/BLUE
14	91165	1	6" AIRLOCK COMPLETE
15	25952	4	3-1/2" U-BOLT MUFFLER CLAMP
16	91260	1	MAGNUM BLOWER
17	28731	2	3/8"-16 X 1" HEX HEAD BOLT
18	28634	2	3/8" FLAT WASHER
19	28526	2	3/8"-16 ESNA LOCK-NUT
20	91083	2	SILENCER MOUNTING BRACKET
21	91855	2	HOSE CLAMP 3" TIGER
22	91843	2	6" WORM-DRIVE HOSE CLAMP
23	28364	1	4" X 3" REDUCER BUSHING
24	91332	1	4" SCH 40 FEMALE PVC ADAPTOR DRILLED
25	90754	1	ELBOW OIL - HOLE COVER
26	91235	1	RUBBER CONNECTOR HOSE/BLOWER

MAGNUM AGGREGATE BOOM CLAMP ASSEMBLY PART NUMBERS

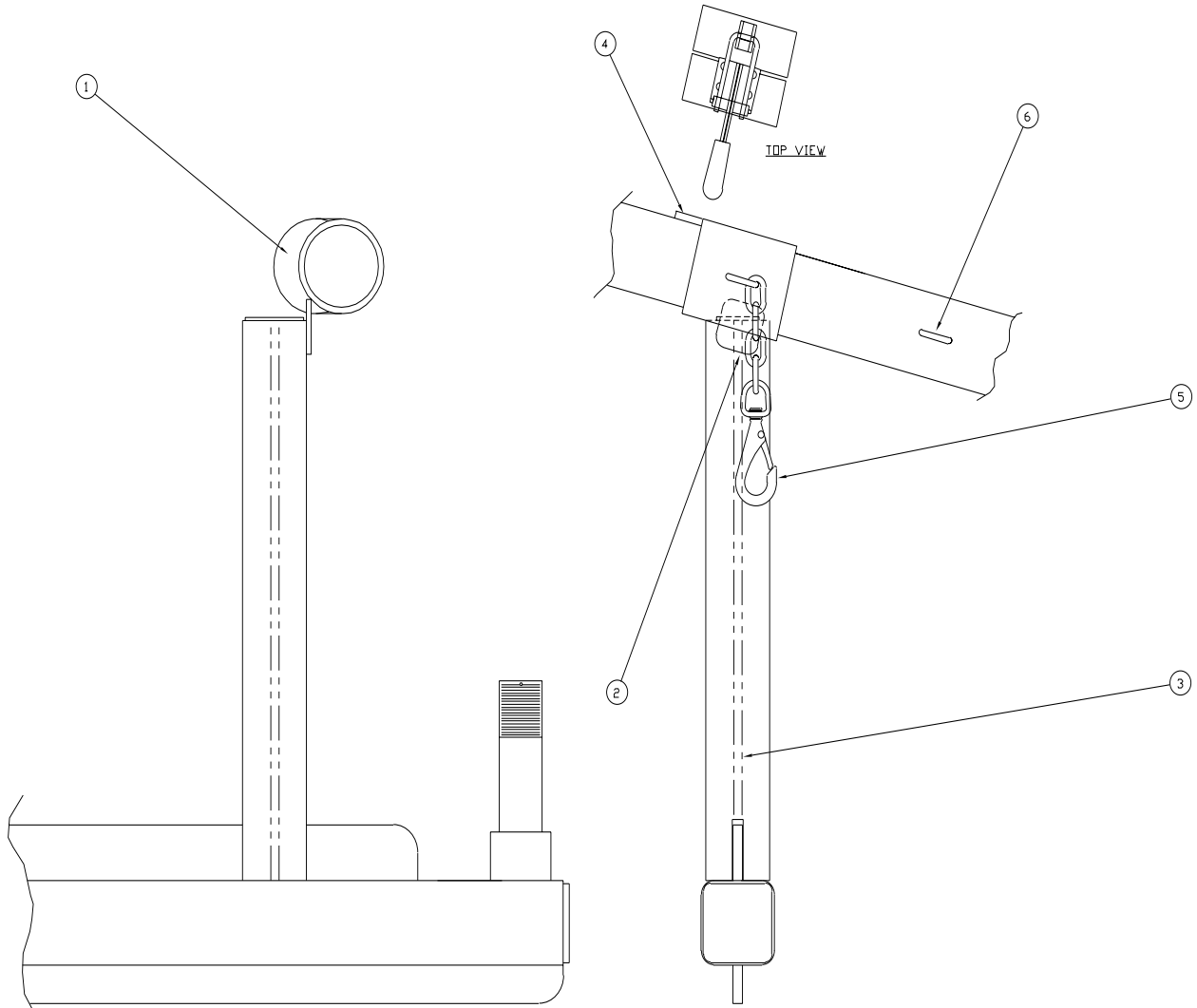

MAGNUM AGGREGATE BOOM CLAMP ASSEMBLY PART NUMBERS

NUMBER	PART NUMBER	QTY	DESCRIPTION
1	91312	1	AGGREGATE BOOM CLAMP ASSEMBLY
2	90490	1	TUBE CAP
3	91310	1	BOOM MOUNT SECTION/FRAME
4	37032	1	1/4" X 1-1/8" KEY
5	91648	1	BOOM STOW SAFETY CHAIN
6	43897	1	3/16" CHAIN, 1 LINK

MAGNUM 6" AGGREGATE SCREW REED ASSEMBLY PART NUMBERS

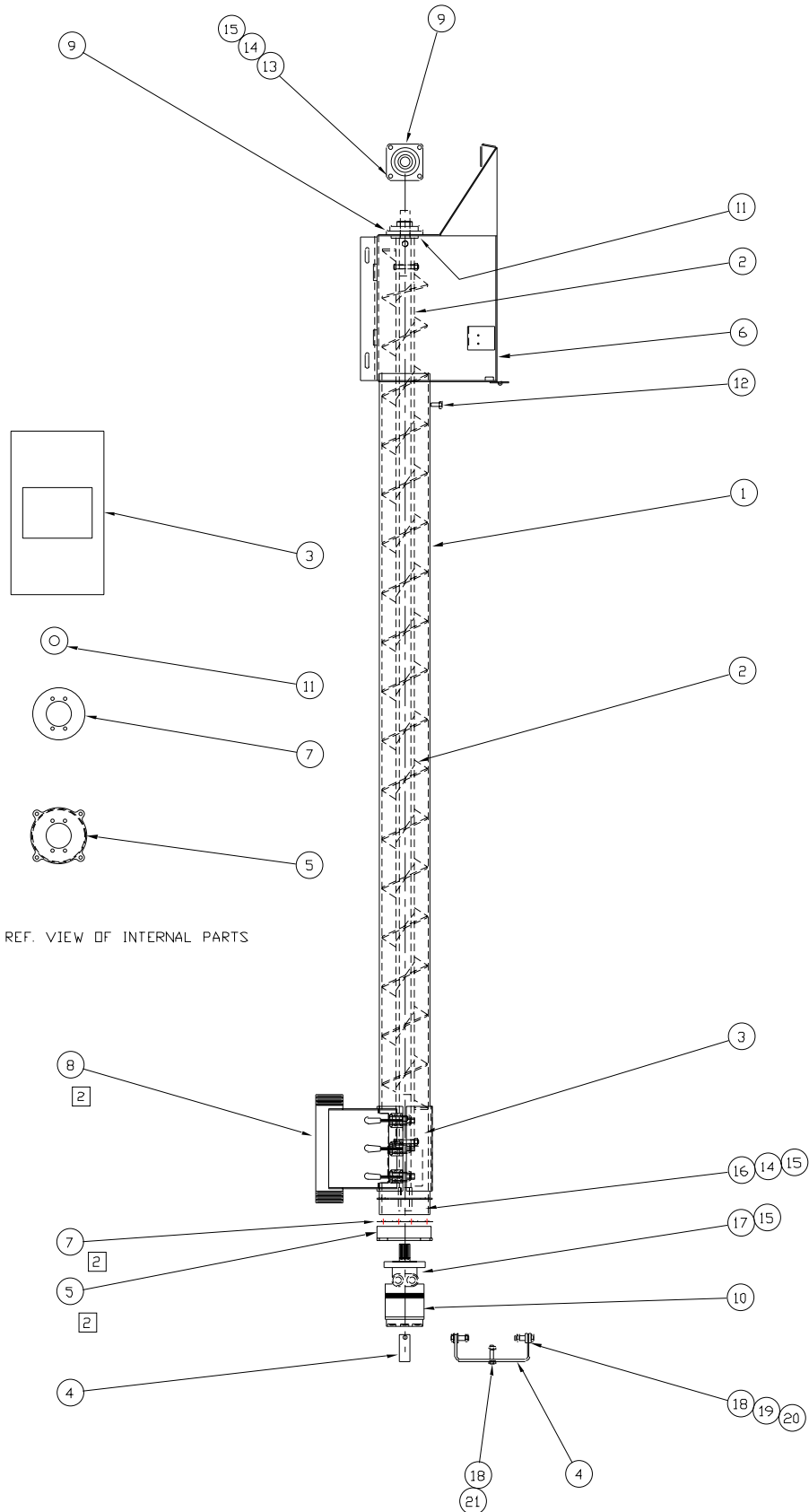

MAGNUM 6" AGGREGATE SCREW REED ASSEMBLY PART NUMBERS

NUMBER	PART NUMBER	QTY	DESCRIPTION
1	91053	1	6" AGGREGATE SCREW FEED PIPE
2	91054	1	6" AGGREGATE FEED SCREW
3	91057	1	AIR LOCK GASKET
4	91106	1	HYDRAULIC MOTOR KEEPING BRACKET
5	91121	1	MOTOR MOUNTING RING
6	91130	1	AGGREGATE HOPPER-MAGNUM
7	91153	1	MOUNTING RING GASKET
8	91165	1	6" AIR LOCK COMPLETE
9	91131	1	1-1/4" HOPPER BEARING
10	91122	1	HYDRAULIC MOTOR
11	91265	1	ANTI-FRICTION NYLON WASHER
12	27956	1	1/2" X 1" GR8 HEX HEAD BOLT
13	27953	4	3/8" X 1" GR8 HEX HEAD BOLT
14	28634	8	3/8" FLAT WASHER
15	28526	12	3/8"-16 ESNA LOCK NUT
16	28729	4	3/8"-16 X 3-1/2" HEX HEAD BOLT
17	28732	4	3/8"-16 X 1-1/4" HEX HEAD BOLT
18	28764	3	1/2"-13 X 2" HEX HEAD BOLT
19	28528	2	1/2"-13 ESNUT
20	28674	4	1/2" FLAT WASHER
21	28504	1	1/2"-13 HEX-NUT STEEL

MAGNUM - ENGINE TO BLOWER DRIVE BELT SYSTEM 3 BELT SYSTEM

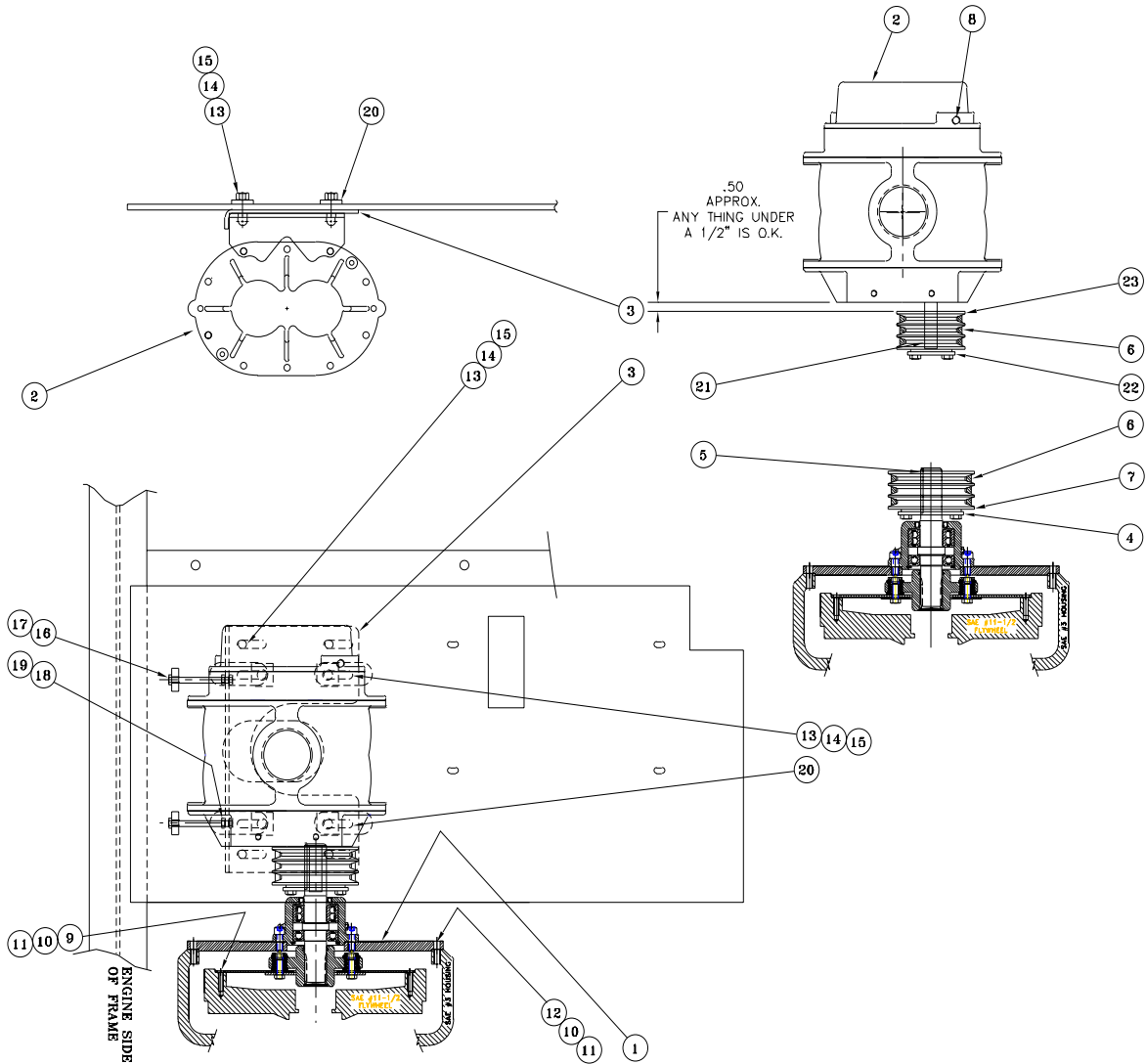

MAGNUM - ENGINE TO BLOWER DRIVE BELT SYSTEM 3 BELT SYSTEM

NUMBER	PART NUMBER	QTY	DESCRIPTION
1	91335	1	BEARING SUPPORT STUB SHAFT
2	60151	1	POSITIVE DISPLACEMENT ROTARY
3	91330	1	BLOWER SLIDE PLATE - MAGNUM
4	91409	1	SDS 1-1/2" BUSHING WITH 3/8"
5	91326	1	ENGINE SHAFT KEY 3/8" - HARDEN
6	92303	3	3V X 300 SUPER HC V-BELT
7	92304	1	3/3V 6.0" QD-SDS SHEAVE
8	60191	0.02	OIL-ROTARY AIR BLOWER
9	27953	8	3/8"-16 NC X 1" GR8 HEX HEAD
10	28641	20	3/8" FLAT HARDENED WASHER
11	28658	20	3/8" LOCK WASHER GRADE 8
12	27955	12	3/8"-16NC X 1-1/4" GR8 HEX HEAD
13	28528	8	1/2"-13 ESNA LOCK-NUT
14	28659	8	1/2" LOCK WASHER GRADE 8
15	29026	8	1/2"-13 X 1-1/2" GR8 BOLT
16	90858	2	3/8"-16 X 4" FULL THREAD BOLT
17	28526	2	3/8"-16 ESNA LOCK NUT
18	27986	2	3/8" FLAT WASHER GRADE 8
19	27964	2	3/8"-16NC GRADE 8 NUT
20	90827	8	BLOWER MOUNTING TAB
21	91065	1	BLOWER KEY - 1/4"
22	92306	1	7/8" SH BUSHING
23	92302	1	3/3V 3.65" QD-SH SHEAVE
24	91327	1	BLOWER KEY - 3/16" X 1-7/8"

MAGNUM EMULSION SUPPLY LINE ROUTING PART NUMBER - 91264

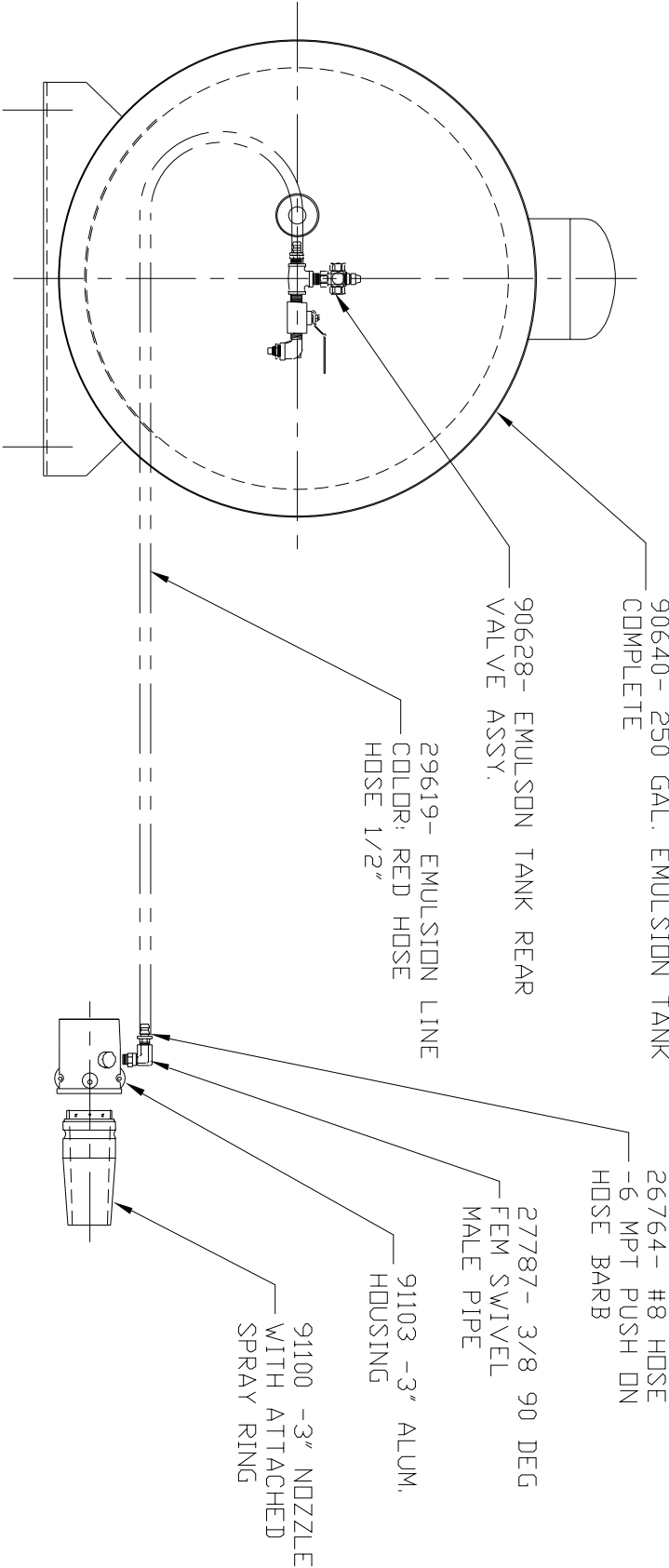

MAGNUM AIR LINE SUPPLY LINE ROUTING PART NUMBER - 91266

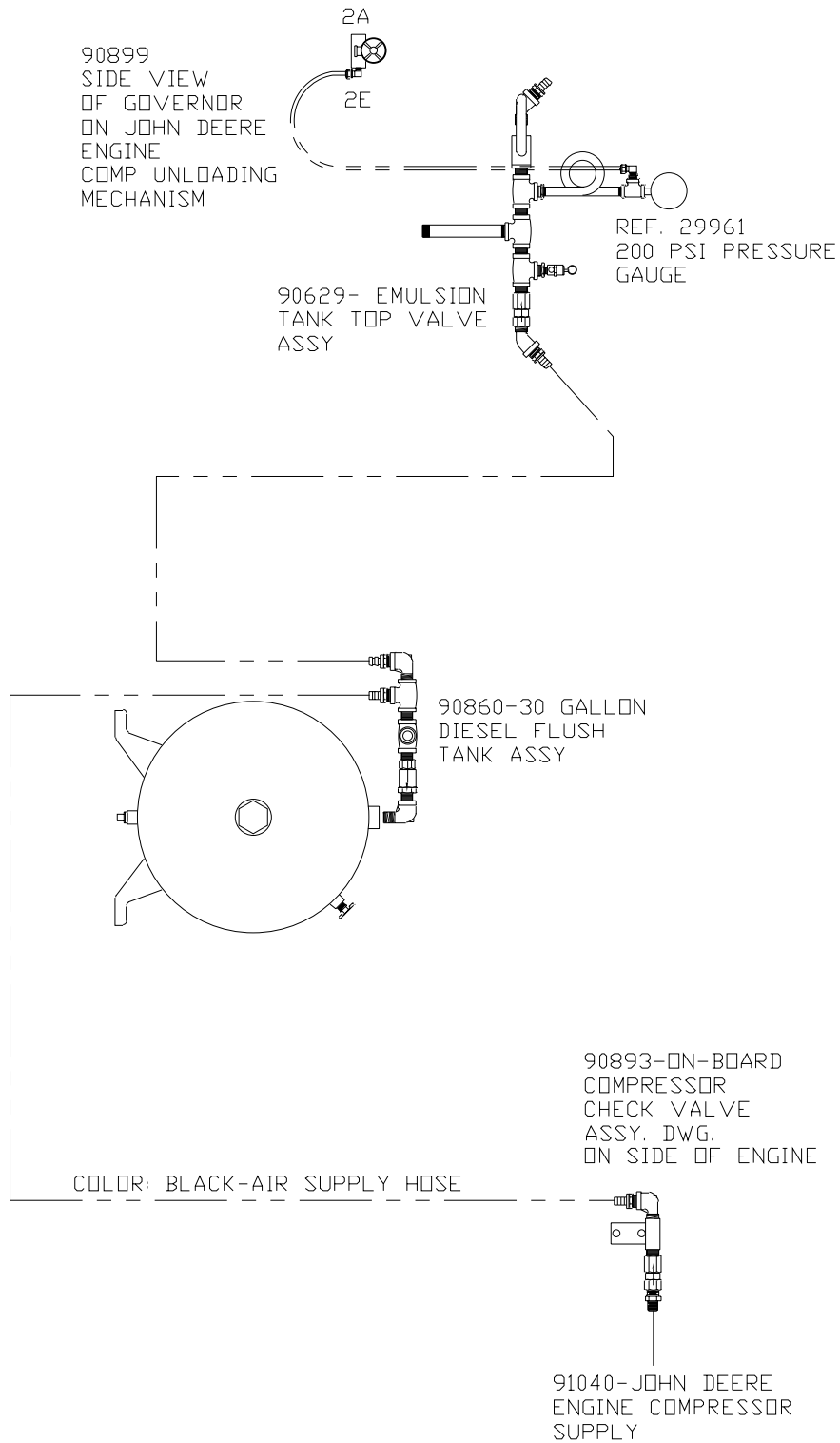

MAGNUM HYDRAULIC SCHEMATIC

PART NUMBER - 92352

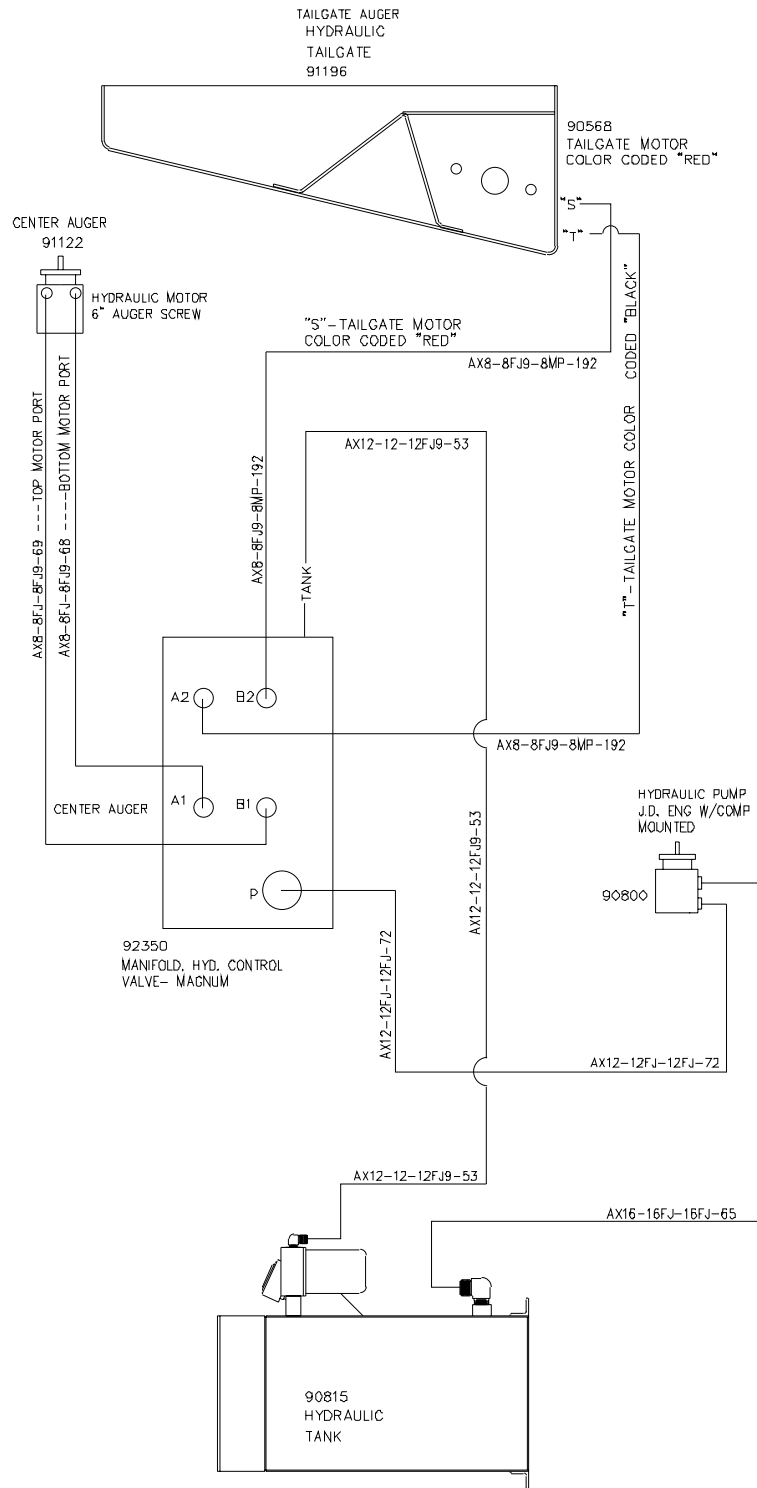

"HYDRAULIC SCHEMATIC MANIFOLD CONTROL VALVE"

HYD. PUMP TO TURNS CLOCKWISE
 HYD. PRESSURE 1500 PSI @ 1500 RPMS
 HYD. PUMP FLOW 22.0 GPM @ 2200 RPMS.

MAGNUM WIRING SCHEMATIC - JOHN DEERE ENGINE

PART NUMBER - 92353

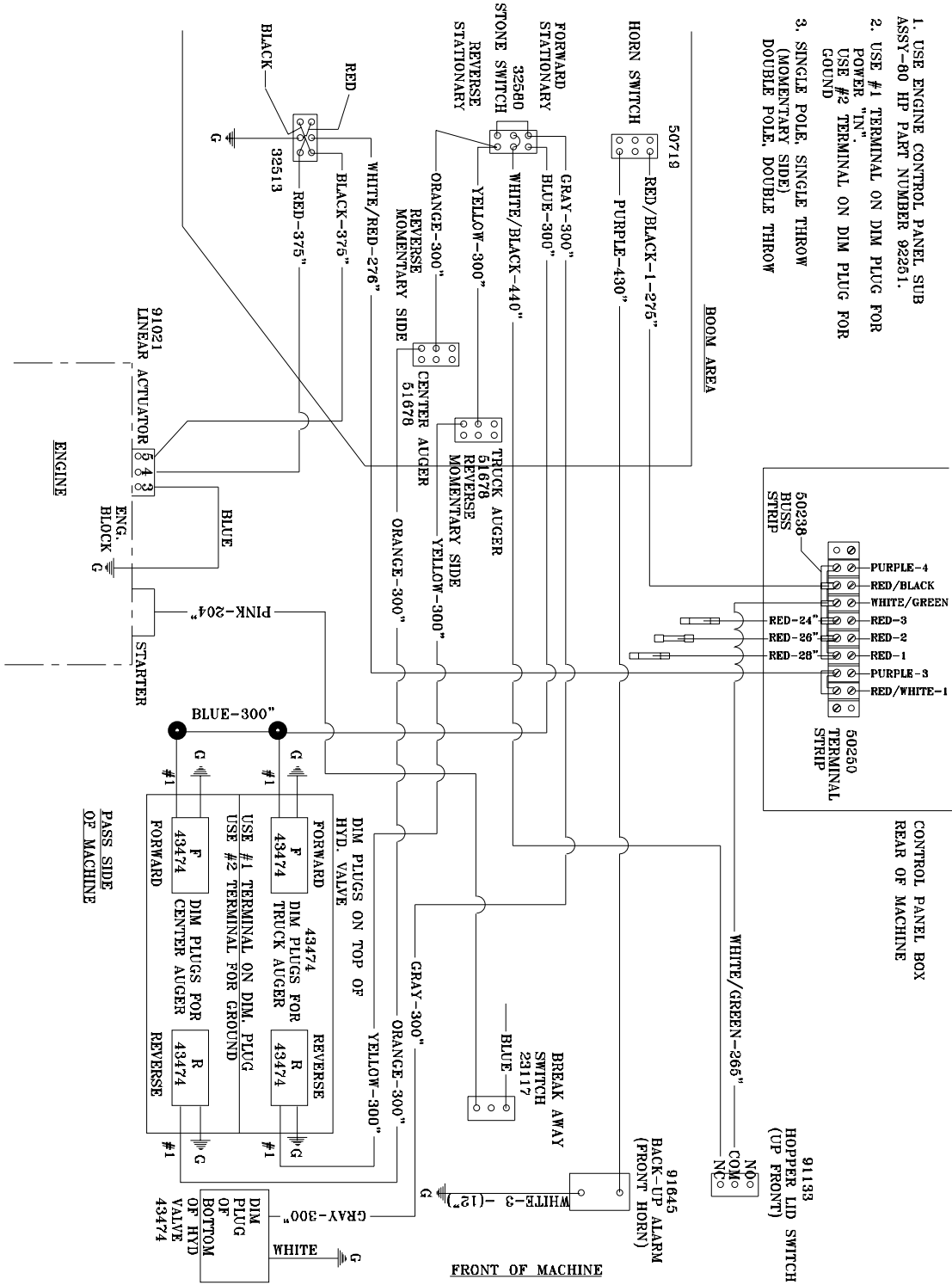

1. USE ENGINE CONTROL PANEL SUB ASSY-80 HP PART NUMBER 92261.
2. USE #1 TERMINAL ON DIM PLUG FOR POWER "IN" USE #2 TERMINAL ON DIM PLUG FOR GROUND
3. SINGLE POLE, SINGLE THROW (MOMENTARY SIDE) DOUBLE POLE, DOUBLE THROW

MAGNUM ENGINE CONTROL PANEL SUBASSEMBLY - 80 HP PART NUMBER - 92251

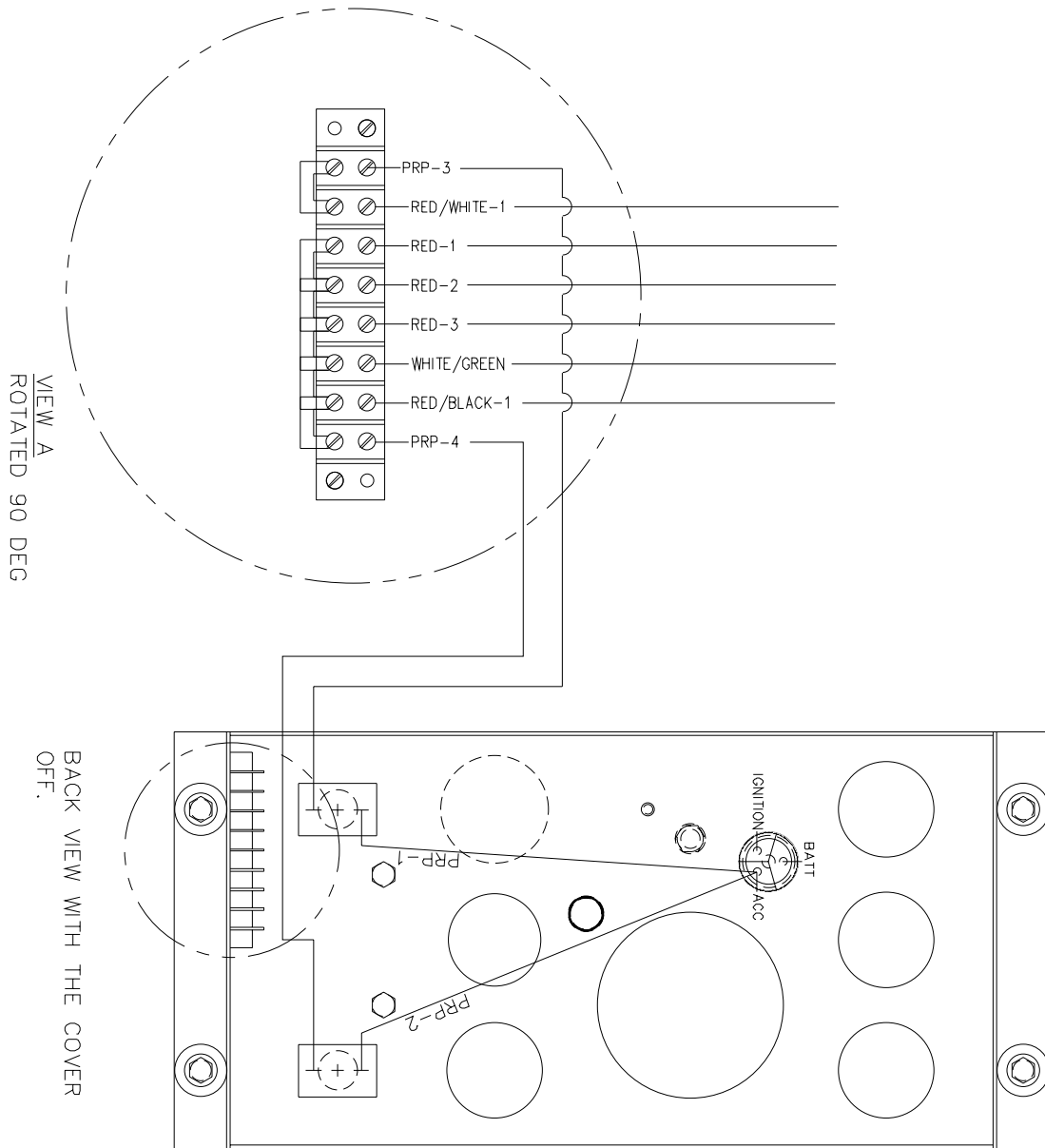

STANDARD DUMP TRUCK AND STANDARD CRAFTCO HYDRAULIC TAILGATE

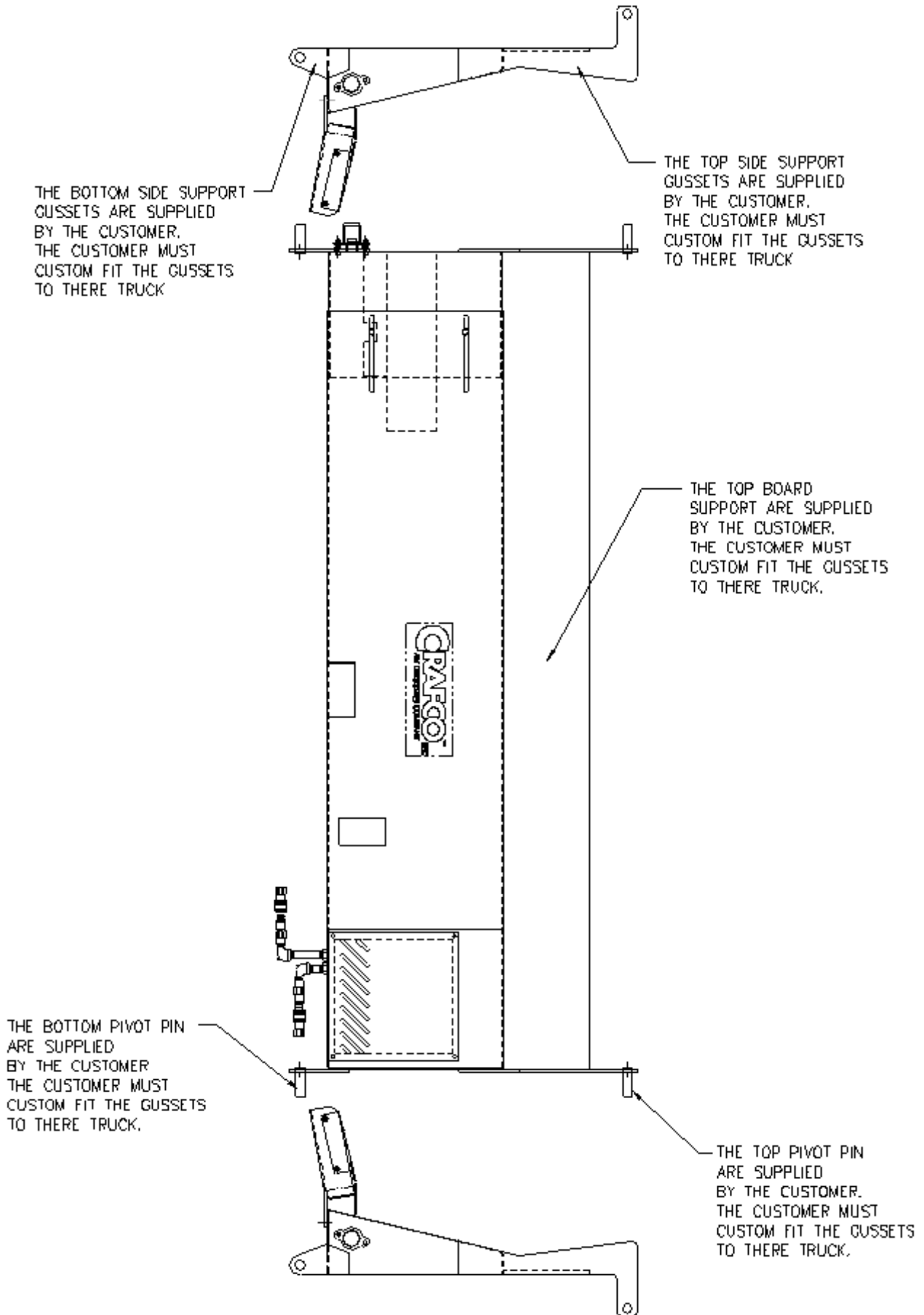

STANDARD DUMP TRUCK WITH STANDARD TAILGATE



NUMBER	DESCRIPTION
1	DUMP TRUCK TOP PIVOT PIN (EXISTING TRUCK PARTS)
2	DUMP TRUCK BOTTOM PIVOT PIN (EXISTING TRUCK PARTS)
3	EXISTING DUMP TRUCK DOOR (EXISTING TRUCK PARTS)

SIDEVIEW OF CRAFCO TAILGATE INSTALLED



NUMBER	PART NUMBER	DESCRIPTION
1	-	SUPPLIED BY THE CUSTOMER; THE TOP SIDE SUPPORT GUSSETS
2	-	SUPPLIED BY THE CUSTOMER; BOTTOM PIVOT PIN
3	91196K	PURCHASED CRAFCO TAILGATE

**TOP SIDE SUPPORT, BOTTOM SIDE SUPPORT,
TOP BOARD INSTALLED BY CUSTOMER TO CRAFCO TAILGATE**



NUMBER	DESCRIPTION
1	TOP SIDE GUSSET
2	TOP PIVOT PIN
3	TOP BOARD
4	TAILGATE SUPPLIED BY CRAFCO, INC.
5	BOTTOM PIVOT PIN
6	BOTTOM SIDE GUSSET

HITCH EXTENSION

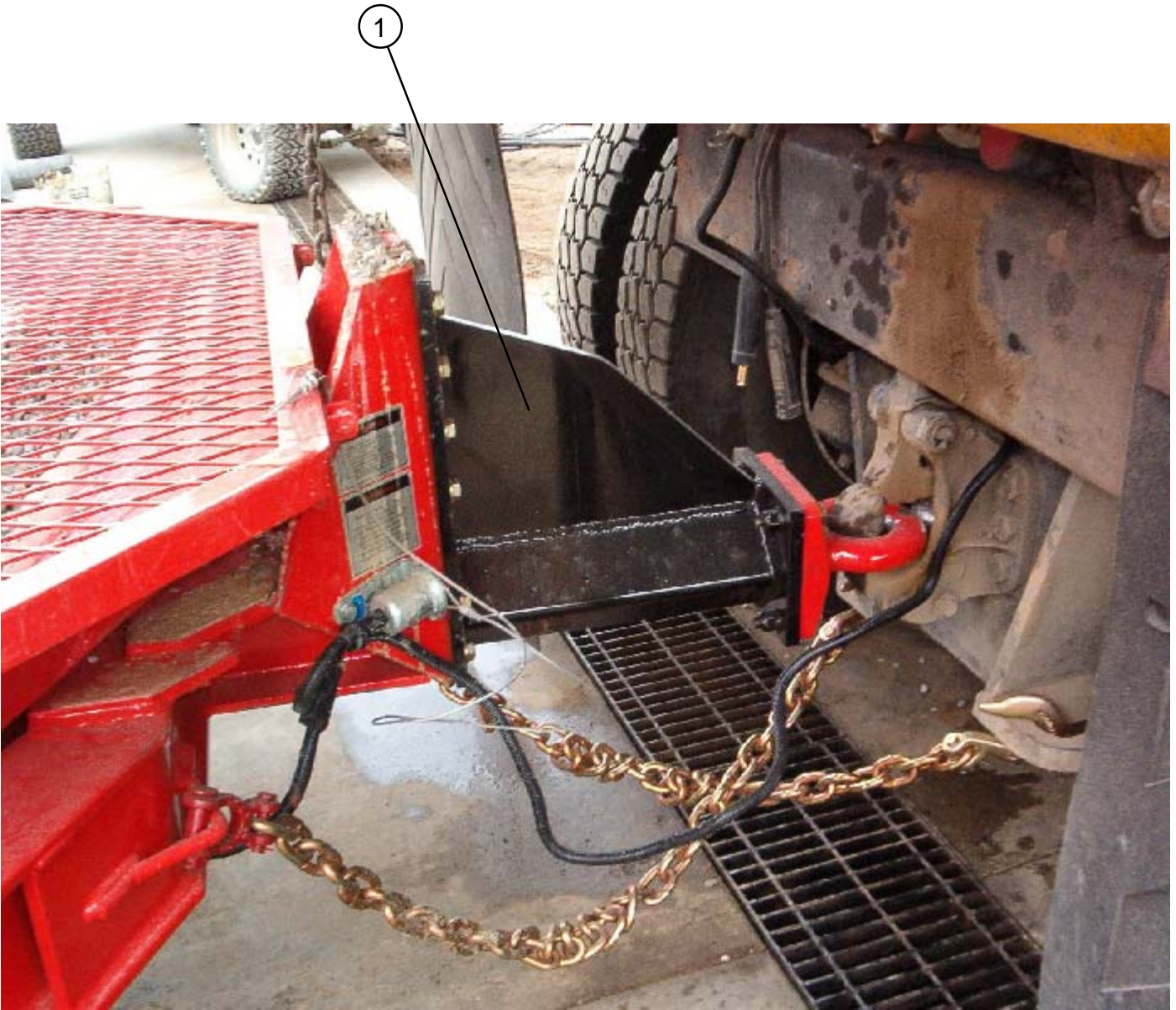

NUMBER	PART NUMBER	QTY	DESCRIPTION
1	90887	1	24" HITCH EXTENSION ASSEMBLY SPECIAL- 19" OFFSET

**Pioneering Leadership and
Innovation in Quality
Pavement Maintenance
Products.**



**235 South Hibbert • Mesa, Arizona 85210
480-655-8333 • Watts 1-800-528-8242
Fax 480-655-1712**

©Copyright 2004 by Crafco, Inc.