



## **SUPER SEALCOATER 550 & 800**

PARTS MANUAL – 70319

REV. "A"

Fill in appropriate fields that apply to this machine.

Machine S/N: \_\_\_\_\_

1st Hose S/N: \_\_\_\_\_

2<sup>nd</sup> Hose S/N: \_\_\_\_\_

1<sup>st</sup> Pump S/N: \_\_\_\_\_

2<sup>nd</sup> Pump S/N: \_\_\_\_\_

Engine S/N: \_\_\_\_\_

Compressor S/N: \_\_\_\_\_

Gear Box S/N (Patcher): \_\_\_\_\_

Blower S/N (Magnum): \_\_\_\_\_

LAST UPDATED: APRIL 2014

## TABLE OF CONTENTS

Crafco Super Sealcoater 550 & 800.....	4
Safety Precautions .....	5
Limited Warranty .....	6
Warranty Claim Instructions .....	7
Contact Us.....	8
Cautions.....	8
<b>Operating Instructions</b>	
Start Up Servicing .....	9
Start Up .....	10
Machine Operations .....	11-13
Material Valve Diagram.....	13-14
Shut Down .....	15-16
<b>Lubricating and Maintenance Instructions.....</b>	<b>17</b>
<b>Crafco Super Sealcoater Parts list.....</b>	<b>18-33</b>
<b>Material System Part List.....</b>	<b>34</b>
<b>Optional Water System Part List.....</b>	<b>35-39</b>
<b>Air System Part List.....</b>	<b>40-42</b>
<b>Hydraulic System List.....</b>	<b>43-46</b>

## **CRAFCO SUPER SEALCOATER 550 & 800**

This manual is furnished with each new **CRAFCO SUPER SEALCOATER 550 & 800**. The manual will help your machine operators learn to run the machine properly and understand its mechanical functions for trouble-free operation.

Your **CRAFCO SUPER SEALCOATER 550 or 800** is designed to give excellent service and save maintenance expense. However, as with all specifically engineered equipment, you can get the best results at minimum cost if:

- 1.) You operate your machine as instructed in this manual.
- 2.) You maintain regularly as stated in this manual.

## SAFETY PRECAUTIONS

- Always wear eye protection, ear protection, and gloves.



- Observe all **CAUTION AND WARNING** signs posted on machine.



- Read Operator Manual thoroughly before operating machine.
- Make sure operator is familiar with machine operation.
- Do not operate in closed building or confined areas.
- Shut-down compressor engine prior to refilling gas tank.
- Keep hands, feet, and clothing away from all moving parts.
- Replace any hoses which show signs of wear, fraying, or splitting. Be sure all fittings and joints are tight and leak-proof.
- Precaution is the best insurance against accidents.
- The CrafcO Super Sealcoater 550 & 800 should not be left unattended when running.
- Tighten all bolts and screws after every 100 hours of operation.



- CRAFCO, Inc. assumes no liability for an accident or injury incurred through improper use of the machine.

## **CRAFCO SUPER SEALCOATER 550 & 800 LIMITED WARRANTY**

Crafco, Inc. through its authorized dealer, will replace for the original purchaser free of charge any parts found upon examination the factory at Chandler, Arizona, to be defective in material or workmanship. The warranty is for a period within 60 days of purchase date, but excludes engine or components, tires, and battery as these items are subject to warranties issued by their manufacturers.

After 60 days Crafco, Inc. warrants structural parts, excluding hydraulic components, material pump and hoses, applicator valves and electric components for a period of (1) one year from date of delivery. Crafco, Inc. shall not be liable for parts that have been damaged by accident, alteration, abuse, improper lubrication/maintenance, normal wear, or other cause beyond our control.

The warranty provides herein extends only to the repair and/ or replacement of those components on equipment covered above and does not cover labor costs. The warranty does not extend to incidental or consequential incurred as a result of any defect covered by this warranty.

All transportation and labor cost incurred by the purchaser in submitting or repairing covered components must be borne by the purchaser.

Crafco, Inc. specifically disavows any other representation, warranty, or liability related to the condition or use of the product.



**WARNING** : Use of replacement parts other than genuine Crafco parts may impair the safety or reliability of your equipment and nullifies any warranty.

# WARRANTY CLAIM INSTRUCTIONS

Crafco, Inc., warrants parts and machinery purchased through Crafco or one of its affiliated distributors for one year from purchased or in-service date \*\*. If parts fail to function within the first year of purchase, a return authorization number (RA) must be obtained. If the part was purchased through Crafco, Inc., please contact the Crafco returns department at Returns@Crafco.com for a RA number or if purchased through a Crafco distributor please contact your distributor. Note: if the part has a serial number associated with it, for example; a machine or electric hose or wand, this must be furnished when requesting the RA number. The customer will be emailed or faxed a RA form with all instructions to return the item to Crafco, Inc. See example. If the part is found to be within the one year warranty period and has not been abused or modified, a credit will be issued to the customer's account or credit card. The customer may request the part be replaced instead of a credit, if desired.

\*\* Wear items are not covered under Crafco, Inc. limited warranty. A wear item is defined as but not limited to: material pumps, sealing tips, tires, etc.  
Note: All engine warranties are covered through the engine manufacture. If you need information for a distributor in your area please contact us and we will direct you to the closest engine distributor.

\*\*\*\* All parts returned are tested and evaluated. If the part has been modified in anyway without prior consent from Crafco, Inc. representative, warranty is void.

Please follow the instructions stated below when calling in a Warranty Claim. Failure to follow these procedures may be cause to void the warranty.

1. Call your local Crafco Distributor. If you do not know who your local distributor is, call a Crafco Customer Service Representative, (Toll Free 1-800-528-8242) for name, location, and telephone number.
2. On contacting the distributor, be prepared to identify the serial number, model number, engine model, engine manufacturer, and the date of purchase if available.
3. Should the cause of the malfunction be a defective part, the Distributor will advise you of the procedure to follow for a replacement.
4. The warranty is valid only for parts, which have been supplied or recommended by Crafco, Inc.

If you have any additional questions regarding warranty repairs and parts, please do not hesitate to call toll free 1-800-528-8242.

# CONTACT US

For Warranty:

Crafco, Inc.

25527 South Arizona Avenue, Chandler, AZ 85248

Phone: (480) 655-8333 or (800) 528-8242

Fax: (480) 655-1712

For all other inquiries:

Crafco, Inc.

420 North Roosevelt Avenue, Chandler, AZ 85226

Phone: (602) 276-0406 or (800) 528-8242

Fax: (480) 961-0513

[CustomerService@crafco.com](mailto:CustomerService@crafco.com)

## CAUTION



- 1.) Never operate machine without all guards in place.
- 2.) Do not allow emulsion to freeze.
- 3.) Do not point the nozzle at another person.
- 4.) Do not operate near an open flame.
- 5.) Do not use any type of flame to unclog the emulsion hose or spray ring if they should become clogged.
- 6.) When spraying material out the hand wand or optional spray bar, wear eye protection.



# **CRAFCO SUPER SEALCOATER 550 & 800 OPERATING PROCEDURES**

## **START UP SERVICING**

The Crafcro Super Sealcoater 550 / 800 are fully serviced and tested prior to shipment. However, shipping regulations do not allow shipment of a fully serviced unit. The following should be checked prior to operation:

### **GASOLINE FUEL TANK**

Fill gasoline fuel tank located on the air compressor unit. Add as needed.

### **AIR COMPRESSOR**

Check oil sight gauge daily for the air compressor pump. Add if required. Read the compressor manufacture's manual supplied with the unit for maintenance.

### **ENGINE**

Check oil level daily. Add if required. Read the engine manufacture's manual supplied with the unit for maintenance.

### **HYDRAULIC OIL TANK**

Check oil level daily. Add if required. Change the hydraulic oil filter every 250 hours. Change the hydraulic oil every 500 hours.

### **ENGINE AIR FILTER**

Read the engine manufacture's manual supplied with the unit for maintenance.

### **COMPRESSOR AIR FILTER**

Read the compressor manufacture's manual supplied with the unit for maintenance.

# CRAFCO SUPER SEALCOATER 550 & 800 OPERATING PROCEDURES

## START UP

- 1.) Make sure all material, air, and water valves are in the closed position.
- 2.) Make sure the hydraulic metering valve is in the neutral position.
- 3.) Open the relief valve on the compressor unit as shown in **Picture 1**. This unloads the pressure on the heads of the compressor pump.
- 4.) Move the grey choke lever on the compressor engine, as shown in **Picture 1**, to the “choke” position.
- 5.) Move the black gas lever on the compressor engine, located just below the grey choke lever shown in **Picture 1** to the on position.
- 6.) Turn the ignition key on the compressor engine to the start position. When the engine turns over and begins running, slide the grey choke lever from the “choke” position to the “off choke” position.
- 7.) Close the relief valve on the compressor unit.
- 8.) Let the compressor unit run until it idles down. When this happens the air tank is full and ready for operation.

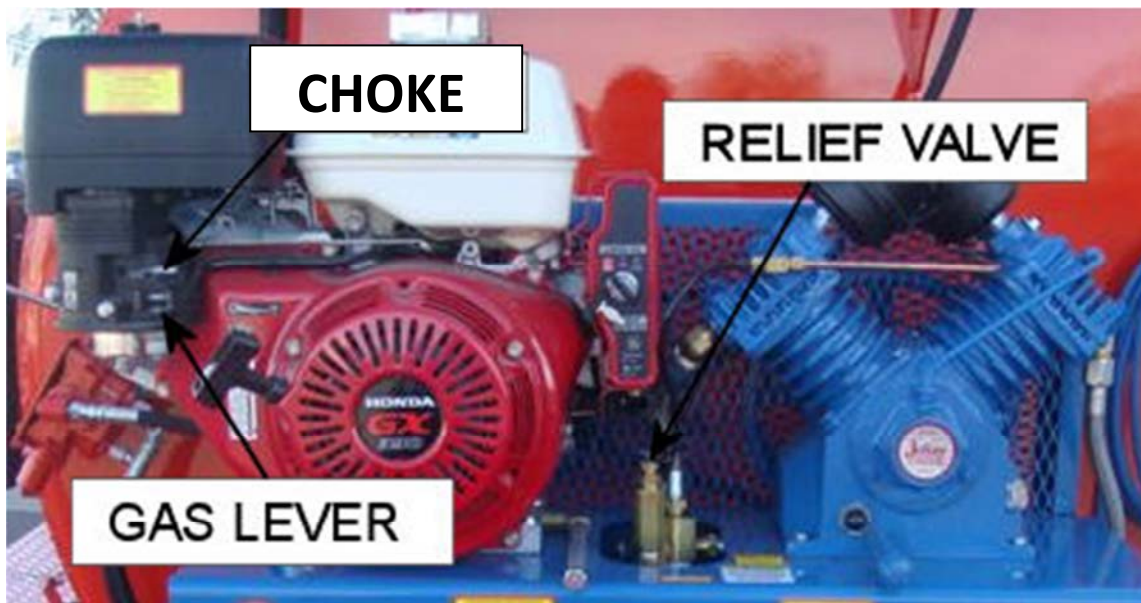

**PICTURE 1**

# CRAFCO SUPER SEALCOATER 550 & 800 OPERATING PROCEDURES

## MACHINE OPERATIONS

### TO AGITATE THE MATERIAL

- 1.) Make sure the compressor unit engine is running.
- 2.) Engage the hydraulic metering valve up, to move the agitator in a clockwise rotation or down, to move the agitator in a counterclockwise rotation. The agitator speed is determined by the position of the handle. The more the handle is moved away from the neutral position the faster the agitator will turn.
- 3.) To stop the agitator, return the hydraulic valve to the neutral position.

**USE THE VALVE DIAGRAMS ON PAGE 13 & 14 FOR THE FOLLOWING STEPS**  
**\*THESE STEPS WERE WRITTEN ASSUMING VALVES ARE CLOSED, THE AIR COMPRESSOR IS RUNNING, THE AIR TANK IS FULL, AND STRAINER BOX LID IS TIGHTENED DOWN\***

### TO LOAD MATERIAL USING AN ALTERNATIVE PUMP

- 1.) Open tank hatch and pump material into tank until desired level is reached.
- OR
- 1.) Remove cam lock cap, and attach a 2" hose to the cam lock fitting just in front of **Material Valve #2.**
  - 2.) Open **Material Valve #1.**
  - 3.) Open **Material Valve #2.**
  - 4.) Pump material into tank until desired level is reached.
  - 5.) Close all valves.
  - 6.) Disconnect hose, and replace the cam lock cap.

### TO LOAD MATERIAL USING THE ON BOARD MATERIAL PUMP

- 1.) Open **Air Valve #6.**
- 2.) Set the Air Regulator to the desired pressure.
- 3.) Remove cam lock cap, and attach a 2" hose to the cam lock fitting just in front of **Material Valve #2.**
- 4.) Make sure the lid on the strainer box is screwed down tight.
- 5.) Open **Material Valve #2.**
- 6.) Open **Material Valve #4.**
- 7.) To begin pumping open **Air Valve #7.**
- 8.) Pump material into tank until desired level is reached.
- 9.) When finished close all valves.
- 10.) Disconnect hose, and replace the cam lock cap.

#### **TO RECIRCULATE THE MATERIAL**

- 1.) Open **Air Valve #6**.
- 2.) Set the Air Regulator to the desired pressure.
- 3.) Open **Material Valve #1**.
- 4.) Open **Material Valve #4**.
- 5.) Open **Air Valve #7** to begin recirculating material back to material tank.
- 6.) When finished close all valves.

#### **TO APPLY MATERIAL USING THE HAND WAND**

- 1.) Open **Air Valve #6**.
- 2.) Set the Air Regulator to the desired pressure.
- 3.) Open **Material Valve #1**.
- 4.) Open **Material Valve #3**.
- 5.) Open and close **Material Valve #8** to control the spray out of the hand wand.
- 6.) When finished close all valves.

#### **TO APPLY MATERIAL USING THE OPTIONAL SPRAY BAR**

- 1.) Open **Air Valve #6**.
- 2.) Set the Air Regulator to the desired pressure.
- 3.) Open **Material Valve #1**.
- 4.) Open **Material Valve #5**.
- 5.) Open and close **Air Valve #7** to turn ON or OFF the spray bar.
- 6.) When finished spraying close all valves.

#### **TO CLEAN OUT MATERIAL HOSE AND HAND WAND USING THE OPTIONAL ON BOARD WATER TANK**

- 1.) Return the agitator control valve to the neutral position.
- 2.) Open **Air Valve #6**.
- 3.) Set the Air Regulator to the desired pressure.
- 4.) Open material tank hatch lid, and splash lid.
- 5.) Remove sand grating.
- 6.) Stick the spray nozzle end of the hand wand into the material tank.
- 7.) Open **Water Valve #9**.
- 8.) Open **Material Valve #3**.
- 9.) Open **Air Valve #7**.
- 10.) Open **Material Valve #8** and spray into material tank until water comes out of the hand wand.
- 11.) When finished close all valves.

### TO DRAIN MATERIAL TANK

- 1.) Remove cam lock cap, and attach a 2" hose to the cam lock fitting just in front of **Material Valve #2**.
- 2.) Open **Material Valve #1**.
- 3.) Let material tank drain.
- 4.) When finished close all valves and replace cam lock cap.

### TO USE THE OPTIONAL WATER HOSE

- 1.) Open **Air Valve #10**.
- 2.) Squeeze and release **Water Nozzle #11** to control spray out the end of the nozzle.
- 3.) When finished close all valves.

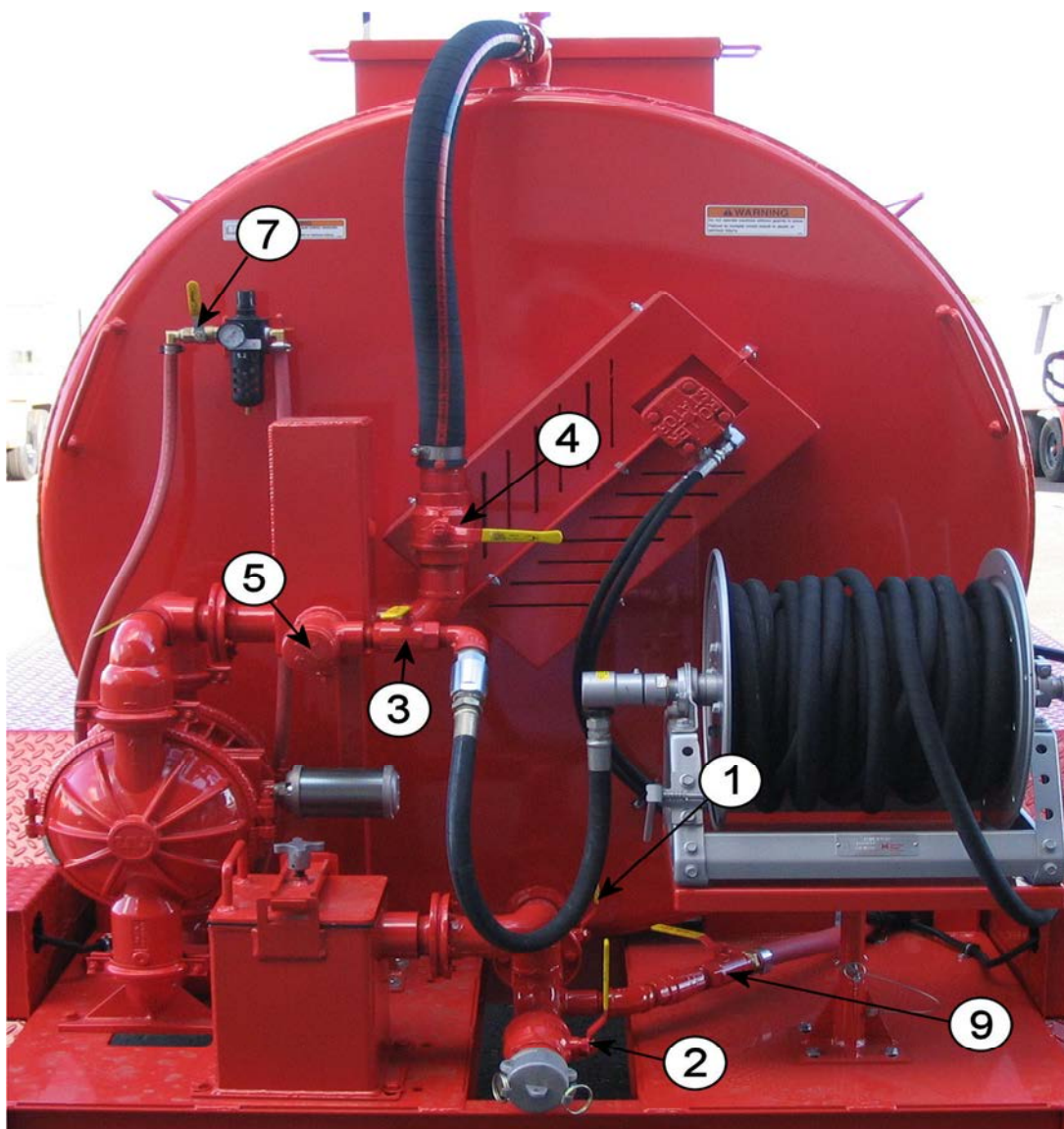

PICTURE 2

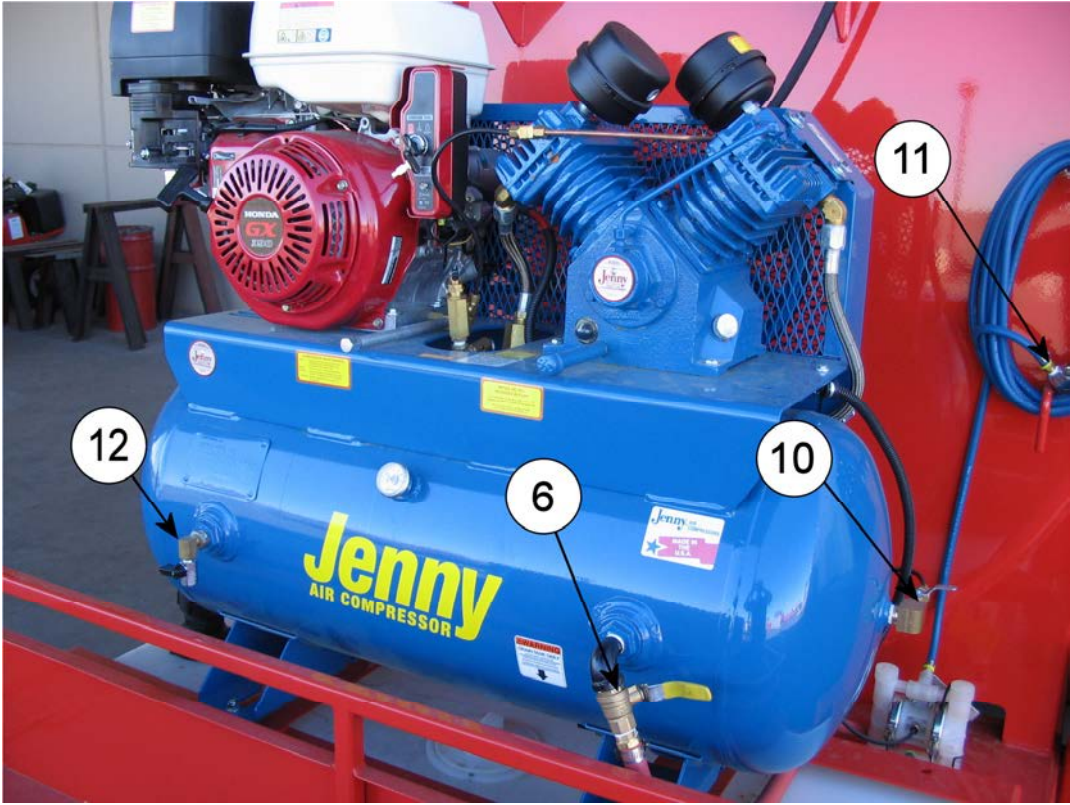

**PICTURE 3**

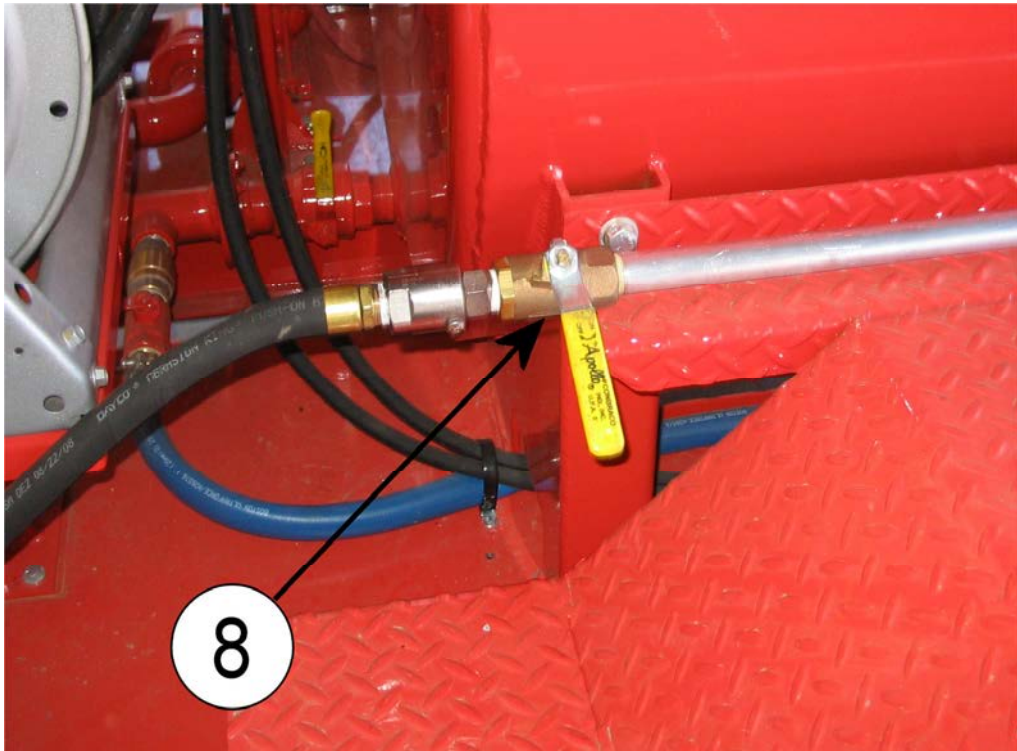

**PICTURE 4**

# CRAFCO SUPER SEALCOATER 550 & 800 OPERATING PROCEDURES

## SHUT DOWN

### 1.) IF SHUTTING DOWN OVER NIGHT

- a.) Return the agitator control valve to the neutral position.
- b.) Turn the ignition key on the compressor unit to the off position.
- c.) Move the black gas lever on the compressor engine, located just below the grey choke lever shown in **Picture 5** to the off position.
- d.) Drain the air from the compressor unit tank by opening **Air Valve #12**.
- e.) Wind up the hand wand hose and lock hose reel.
- f.) Return hand wand to hand wand storage tab. Place the nozzle end of wand into drip tube.
- g.) Lock hand wand into storage tabs.
- h.) Return all equipment to storage deck and tie down.
- i.) Lock storage deck ramp in the up position.
- j.) Close all valves on the machine.

### 2.) IF SHUTTING DOWN FOR LONGER THAN 2 DAYS

- a.) Follow the material hose and hand wand cleanout procedure on page 12.
- b.) Turn the ignition key on the compressor unit to the off position.
- c.) Move the black gas lever on the compressor engine, located just below the grey choke lever shown in **Picture 5** to the off position.
- d.) Drain the air from the compressor unit tank by opening **Air Valve #12**.
- e.) Wind up the hand wand hose and lock hose reel.
- f.) Return hand wand to hand wand storage tab. Place the nozzle end of wand into drip tube.
- g.) Lock hand wand into storage tabs.
- h.) Return all equipment to storage deck and tie down.
- i.) Lock storage deck ramp in the up position.
- j.) Place all brooms and squeegees in brush box.
- k.) Close all valves on the machine.



**PICTURE 5**



# **CRAFCO SUPER SEALCOATER 550 & 800 OPERATING PROCEDURES**

## **LUBRICATING AND MAINTENANCE INSTRUCTIONS**

1. Compressor Unit – Refer to separate manual in packet. (Air Compressor Manual)
2. Engine - Refer to separate manual in packet. (Engine Manual)
3. 2" Material Pump – Refer to separate manual in packet. (Material Pump Manual)
4. 1/4" Water Pump – Refer to separate manual in packet. (Water Pump Manual)
5. Check hydraulic oil level every day.
6. Check and tighten all bolts periodically, including axles (Approximately 100 hours).
7. Replace the hydraulic oil filter every 250 hours.
8. Lubricate agitator shaft bearings every 100 hours.
9. Lubricate agitator drive chain every 250 hours.

## CRAFCO SUPER SEALCOATER 550 & 800 PART LIST



**PICTURE 6**

NUMBER	PART NUMBER	DESCRIPTION
1	70005	SEALCOAT MACHINE TRAILER ASSEMBLY
2	70025 70525	550 GAL SEALCOAT MACHINE TANK OR 800 GAL SEALCOAT MACHINE TANK
3	70210	BRUSH BOX ASSEMBLY
4	70309	OPTIONAL WATER TANK KIT
5	70075	FENDER ASSEMBLY – PASSENGERSIDE
6	70248	HAND WAND ASSEMBLY COMPLETE
7	90100	16" TIRE & RIM ASSEMBLY
8	25289	RECORD BOX
9	23117	BREAKAWAY SWITCH
10	20014	HITCH 3" PINTLE ASSEMBLY
11	24290	LIGHT, SIDE MARKER
12	70255	HAND WAND DRIP TUBE

**CRAFCO SUPER SEALCOATER 550 & 800  
PART LIST**

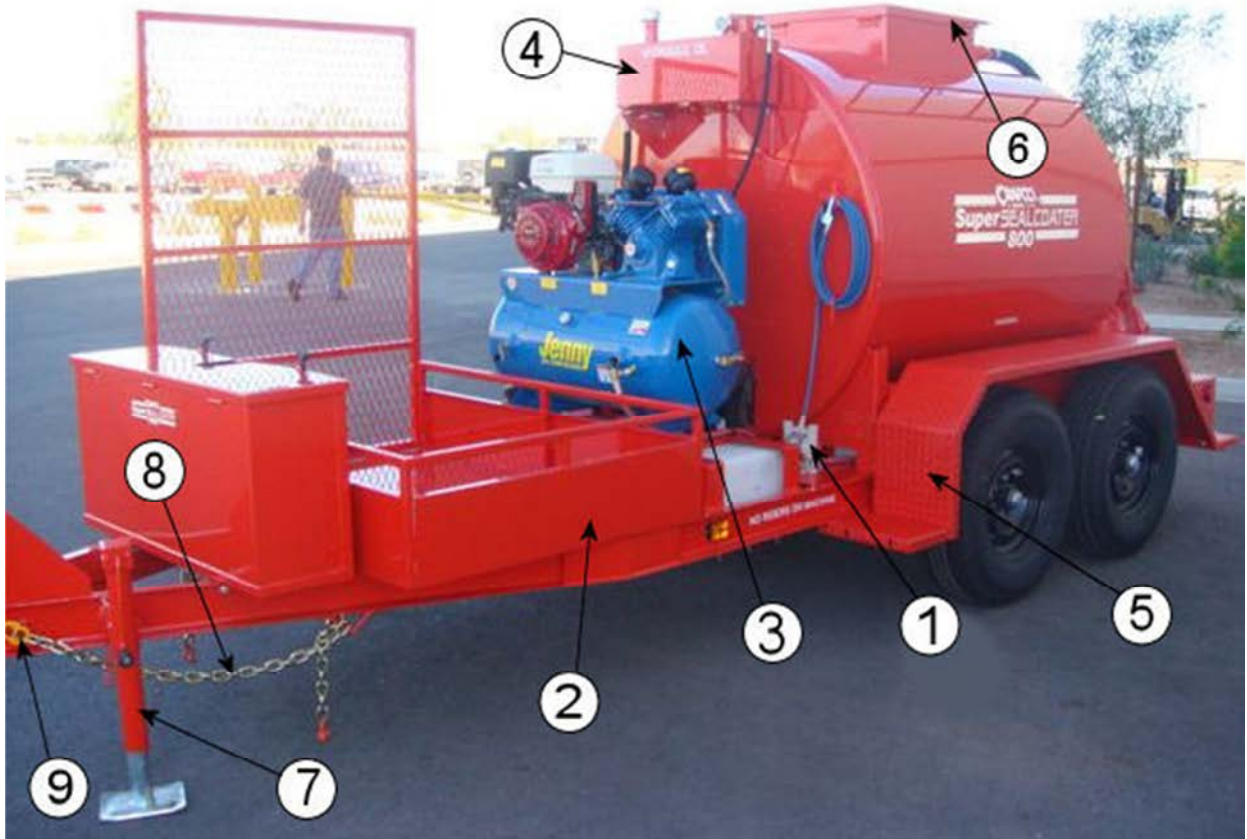

**PICTURE 7**

<b>NUMBER</b>	<b>PART NUMBER</b>	<b>DESCRIPTION</b>
<b>1</b>	<b>70173</b>	<b>0.25 AIR DIAPHRAGM PUMP</b> (PART OF WATER TANK OPTION)
<b>2</b>	<b>70050</b>	<b>STORAGE DECK ASSEMBLY</b>
<b>3</b>	<b>70308</b>	<b>AIR COMPRESSOR ASSEMBLY COMPLETE</b>
<b>4</b>	<b>70100</b>	<b>HYD. OIL TANK ASSEMBLY</b>
<b>5</b>	<b>70076</b>	<b>FENDER ASSEMBLY - DRIVERSIDE</b>
<b>6</b>	<b>70140</b>	<b>MATERIAL HATCH LID ASSEMBLY</b>
<b>7</b>	<b>23082</b>	<b>JACK, 7000#, 15" STROKE</b>
<b>8</b>	<b>20130</b>	<b>CHAIN 3/8 PROOF COIL</b>
<b>9</b>	<b>20132</b>	<b>SHACKLE, CHAIN CONNECTING LINK</b>

## CRAFCO SUPER SEALCOATER 550 & 800 PART LIST

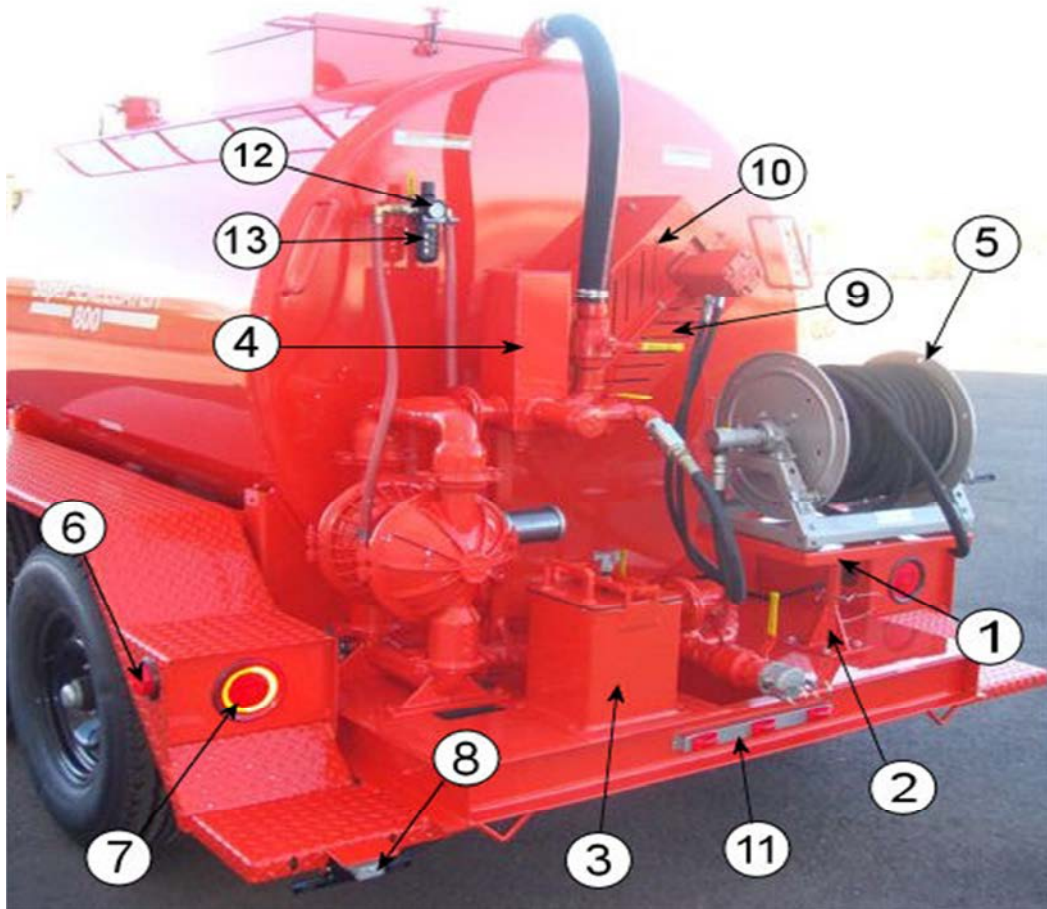

**PICTURE 8**

NUMBER	PART NUMBER	DESCRIPTION
1	70200	HOSE REEL MOUNTING PLATE ASSEMBLY
2	70204	HOSE REEL STAND BASE
3	70110	STRAINER BOX ASSEMBLY
4	70125	EXPANSION TANK ASSEMBLY
5	70206	MANUAL HOSE REEL
6	44773	SIDE MARKER LIGHT
7	44771	TAIL-LIGHT
8	90544	LICENSE PLATE BRACKET WITH LIGHT
9	70257	AGITATOR SPROCKET BOTTOM GUARD
10	70258	AGITATOR SPROCKET TOP GUARD
11	24128	LIGHT, RED CLEARANCE
12	70241	½" AIR REGULATOR & FILTER
13	70242	AIR PRESSURE GAUGE – 0-160 P.S.I.

**CRAFCO SUPER SEALCOATER 550 & 800  
PART LIST**

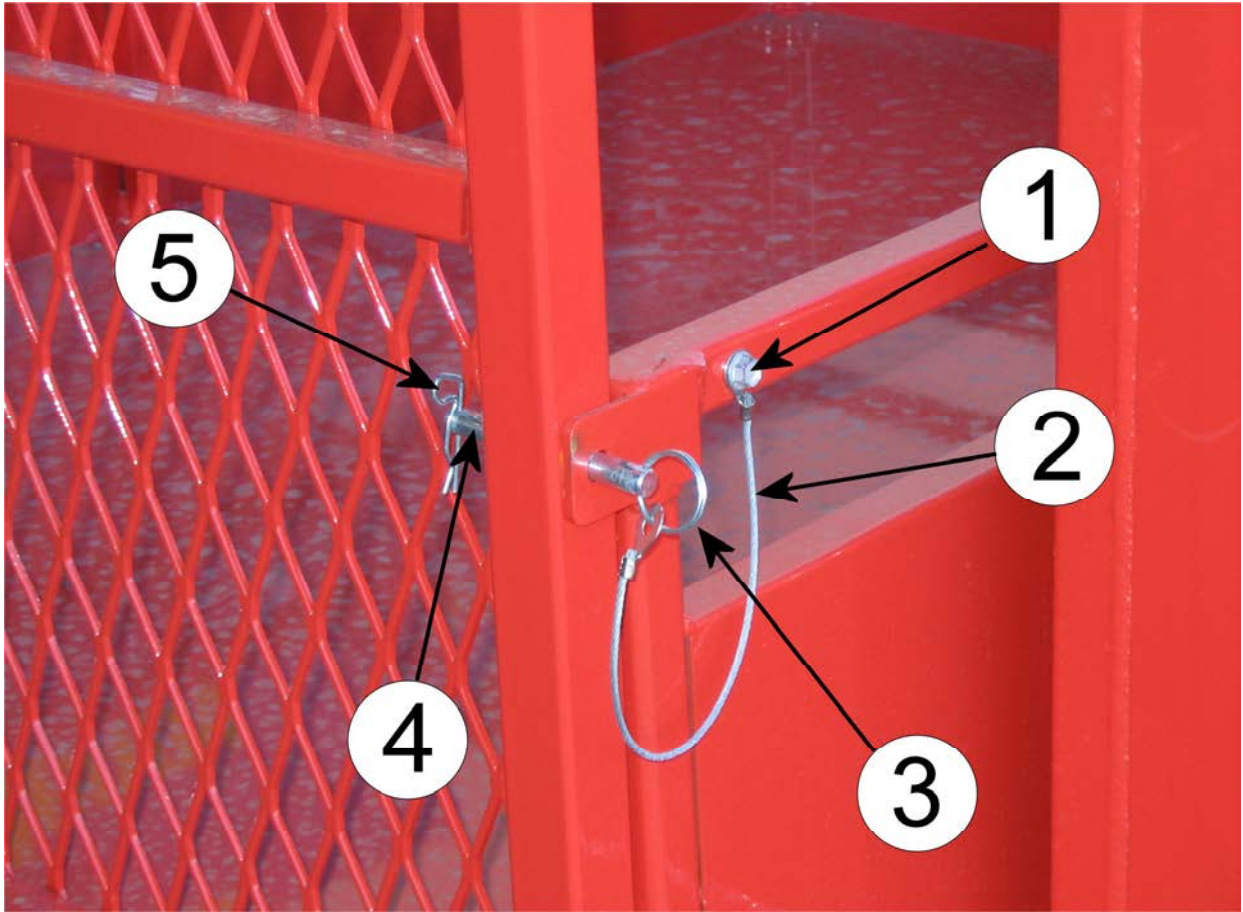

**STORAGE DECK ASSEMBLY PART# 70050**

<b>NUMBER</b>	<b>PART NUMBER</b>	<b>DESCRIPTION</b>
<b>1</b>	<b>28985</b>	<b>1/4" X 3/4" SELF TAP SCREW</b>
<b>2</b>	<b>44157</b>	<b>PIN ATTACHMENT</b>
<b>3</b>	<b>70068</b>	<b>SPLIT RING</b>
<b>4</b>	<b>70060</b>	<b>3/8" DIA. CLEVIS PIN</b>
<b>5</b>	<b>70067</b>	<b>HAIRPIN</b>

**CRAFCO SUPER SEALCOATER 550 & 800  
PART LIST**

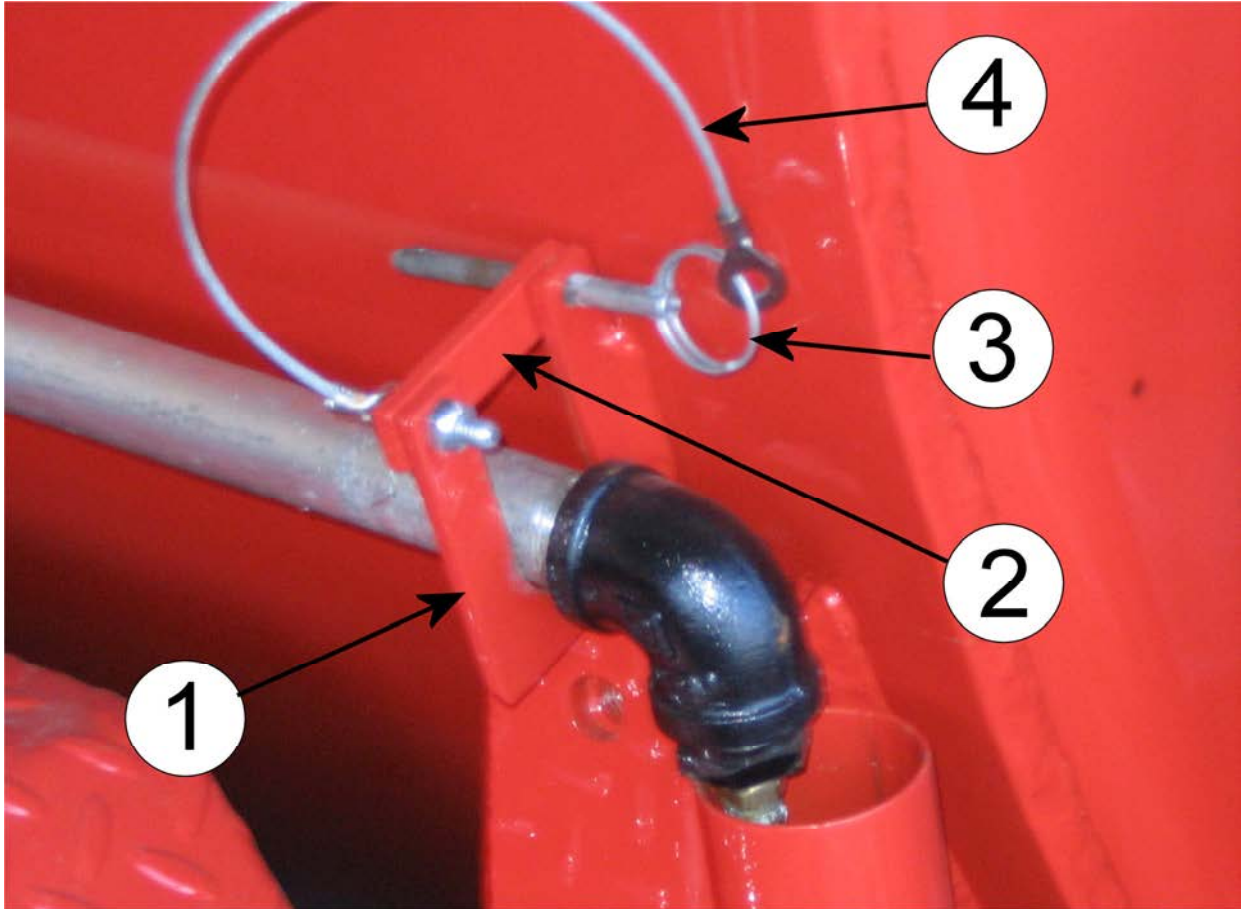

**HAND WAND STORAGE TAB**

<b>NUMBER</b>	<b>PART NUMBER</b>	<b>DESCRIPTION</b>
<b>1</b>	<b>70044</b>	<b>HAND WAND STORAGE TAB</b>
<b>2</b>	<b>70045</b>	<b>HAND WAND STORAGE TAB CLAMP</b>
<b>3</b>	<b>26104</b>	<b>¼" X 2 ½" QUICK PIN</b>
<b>4</b>	<b>44157</b>	<b>PIN ATTACHMENT</b>

**CRAFCO SUPER SEALCOATER 550 & 800  
PART LIST**

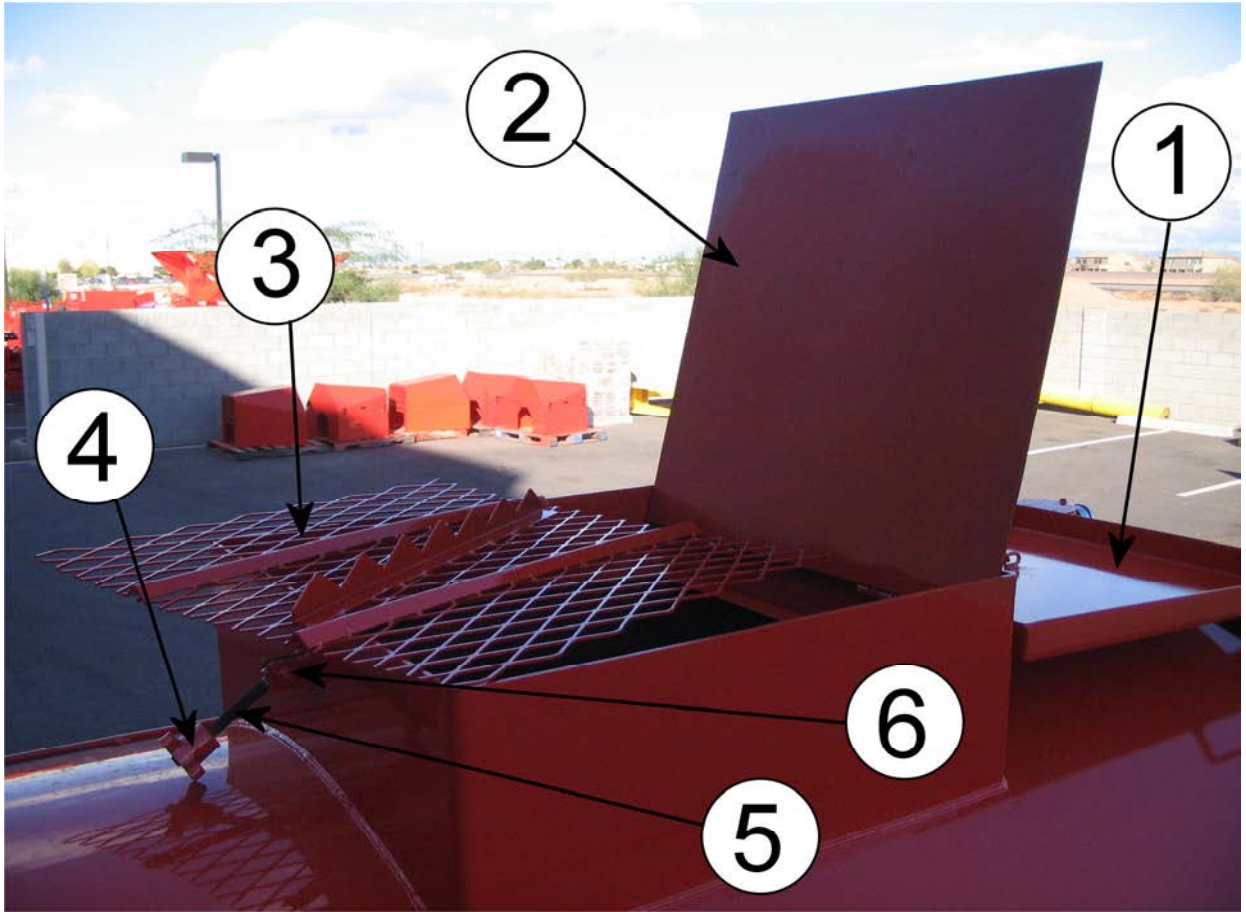

**MATERIAL TANK HATCH LIDS**

<b>NUMBER</b>	<b>PART NUMBER</b>	<b>DESCRIPTION</b>
<b>1</b>	<b>70140</b>	<b>HATCH LID ASSEMBLY</b>
<b>2</b>	<b>70142</b>	<b>SPLASH LID ASSEMBLY</b>
<b>3</b>	<b>70144</b>	<b>SAND GRATING ASSEMBLY</b>
<b>4</b>	<b>56816</b>	<b>CAST IRON KNOB</b>
<b>5</b>	<b>56815</b>	<b>FEMALE THREADED ROD</b>
<b>6</b>	<b>56814</b>	<b>PLATE LID PIVOT BRACKET</b>

**CRAFCO SUPER SEALCOATER 550 & 800  
PART LIST**

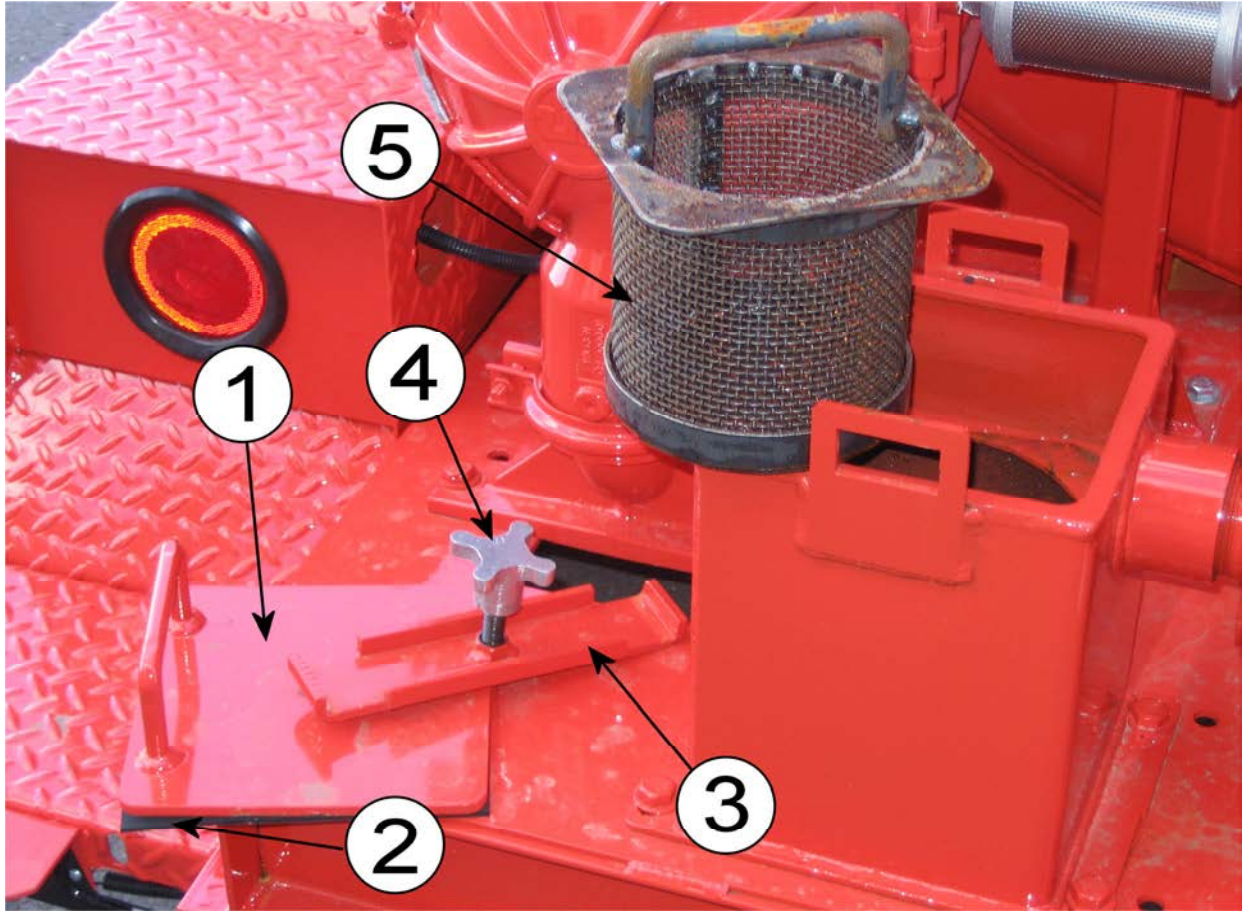

**STRAINER BOX**

<b>NUMBER</b>	<b>PART NUMBER</b>	<b>DESCRIPTION</b>
<b>1</b>	<b>70117</b>	<b>STRAINER BOX LID ASSEMBLY</b>
<b>2</b>	<b>70137</b>	<b>STRAINER BOX LID GASKET</b>
<b>3</b>	<b>70120</b>	<b>STRAINER BOX LID STRAP ASSEMBLY</b>
<b>4</b>	<b>70122</b>	<b>STRAINER BOX CLAMPING KNOB</b>
<b>5</b>	<b>70225</b>	<b>STRAINER BASKET ASSEMBLY</b>



**CRAFCO SUPER SEALCOATER 550 & 800  
PART LIST**

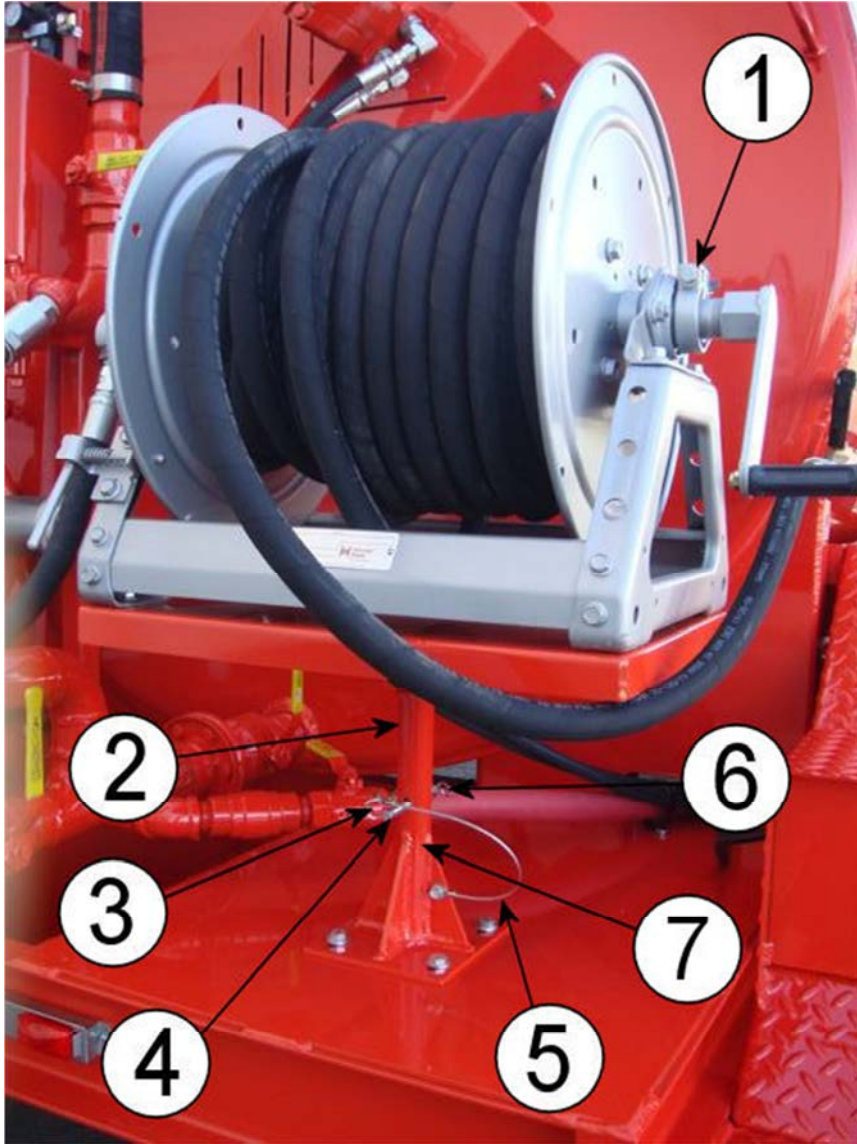

**HOSE REEL STAND**

<b>NUMBER</b>	<b>PART NUMBER</b>	<b>DESCRIPTION</b>
<b>1</b>	<b>70206</b>	<b>MANUAL HOSE REEL</b>
<b>2</b>	<b>70200</b>	<b>HOSE REEL MOUNTING PLATE ASSEMBLY</b>
<b>3</b>	<b>70068</b>	<b>SPLIT RING</b>
<b>4</b>	<b>70060</b>	<b>3/8" CLEVIS PIN</b>
<b>5</b>	<b>44157</b>	<b>PIN ATTACHMAENT CABLE</b>
<b>6</b>	<b>70067</b>	<b>HAIRPIN</b>
<b>7</b>	<b>70204</b>	<b>HOSE REEL STAND BASE ASSEMBLY</b>

**CRAFCO SUPER SEALCOATER 550 & 800  
PART LIST**

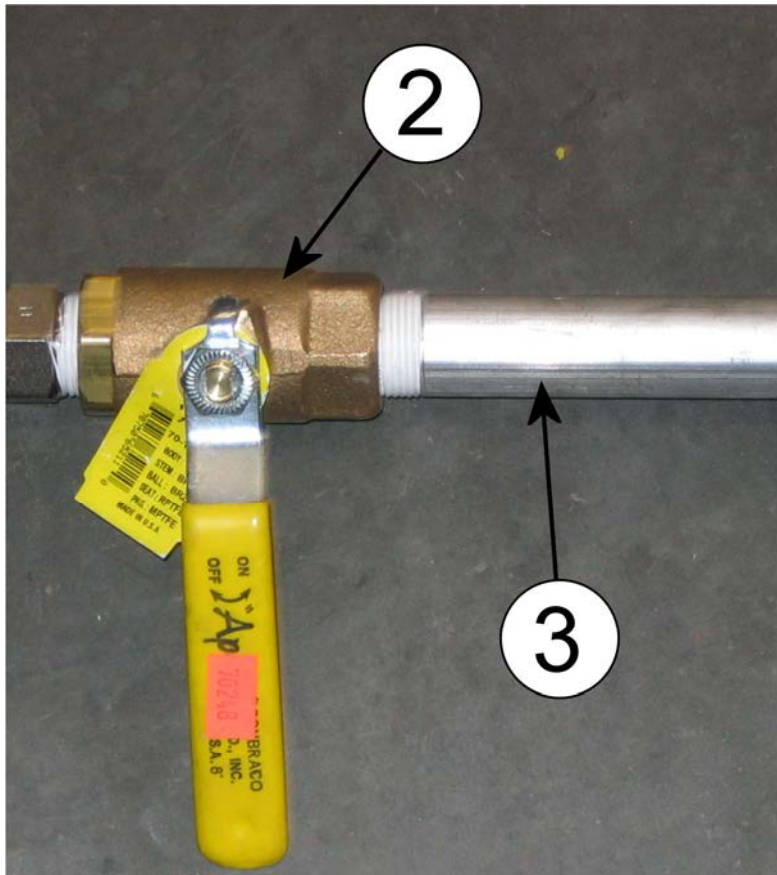

**HAND WAND ASSEMBLY PICTURE 1**

<b>NUMBER</b>	<b>PART NUMBER</b>	<b>DESCRIPTION</b>
<b>2</b>	<b>29227</b>	<b>¾ BALL VALVE</b>
<b>3</b>	<b>70249</b>	<b>HAND WAND BODY</b>

**CRAFCO SUPER SEALCOATER 550 & 800  
PART LIST**

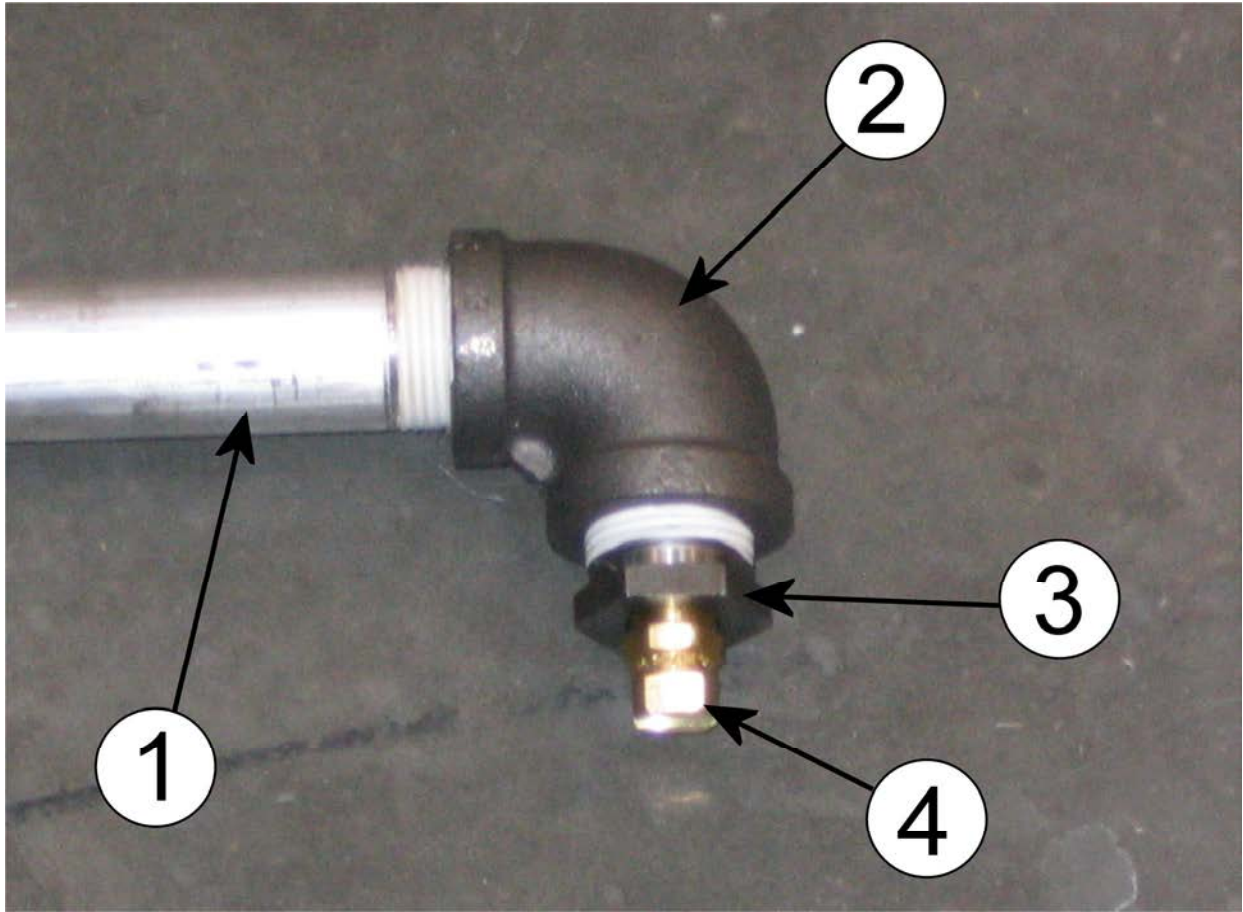

**HAND WAND ASSEMBLY PICTURE 2**

<b>NUMBER</b>	<b>PART NUMBER</b>	<b>DESCRIPTION</b>
<b>1</b>	<b>70249</b>	<b>HAND WAND BODY</b>
<b>2</b>	<b>28209</b>	<b><math>\frac{3}{4}</math>" 90° PIPE ELBOW</b>
<b>3</b>	<b>28346</b>	<b>BUSHING, <math>\frac{3}{4}</math>" X <math>\frac{1}{4}</math>"</b>
<b>4</b>	<b>70268</b>	<b>FLAT SPRAY NOZZLE 80/50</b>

**CRAFCO SUPER SEALCOATER 550 & 800  
PART LIST**

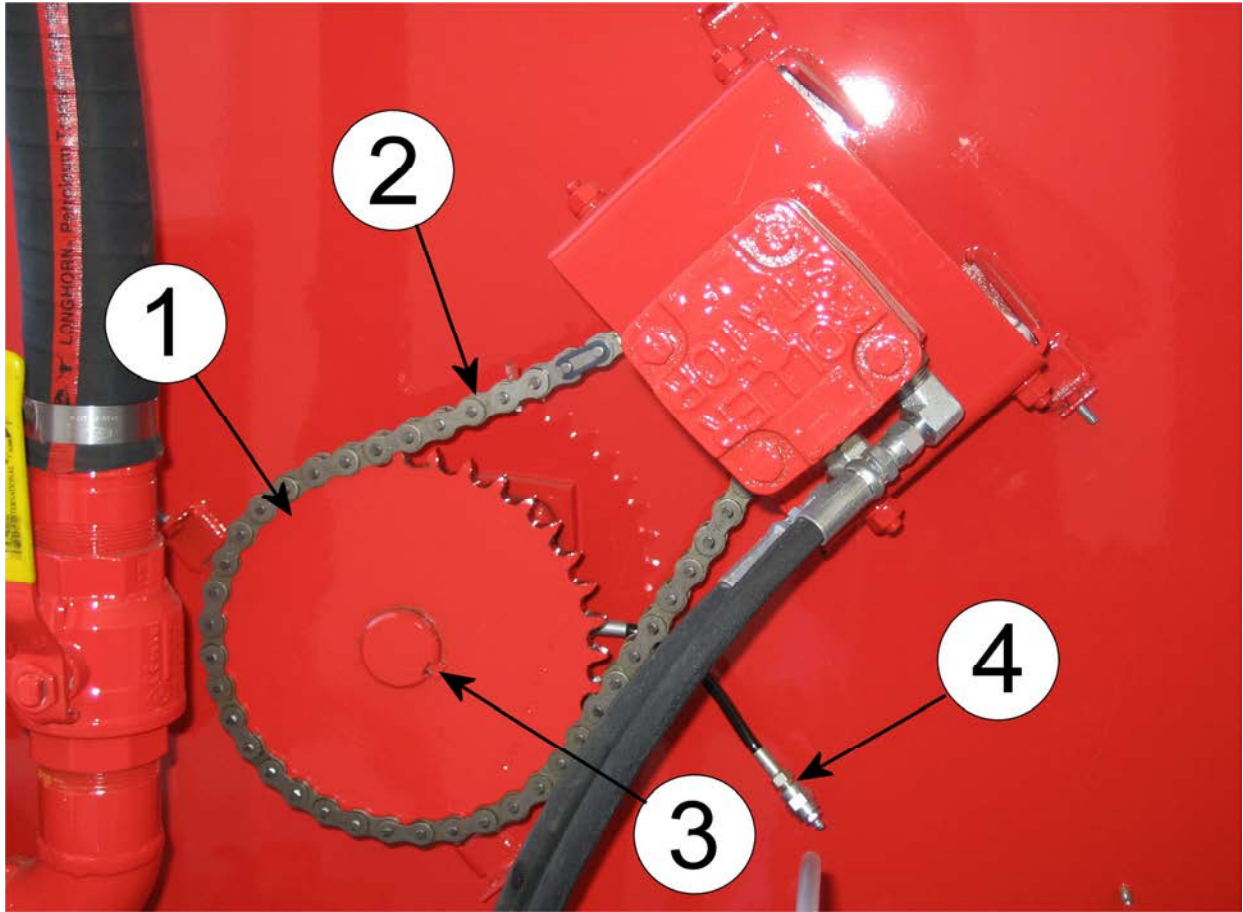

**AGITATOR DRIVE PICTURE 1**

<b>NUMBER</b>	<b>PART NUMBER</b>	<b>DESCRIPTION</b>
<b>1</b>	<b>70238</b>	<b>NO. 60 - 36 TOOTH SPROCKET</b>
<b>2</b>	<b>70240</b>	<b>NO. 60 ROLLER CHAIN</b>
<b>3</b>	<b>70233</b>	<b>AGITATOR SHAFT KEY</b>
<b>4</b>	<b>70307</b>	<b>GREASE LINE</b>

**CRAFCO SUPER SEALCOATER 550 & 800**  
**PART LIST**

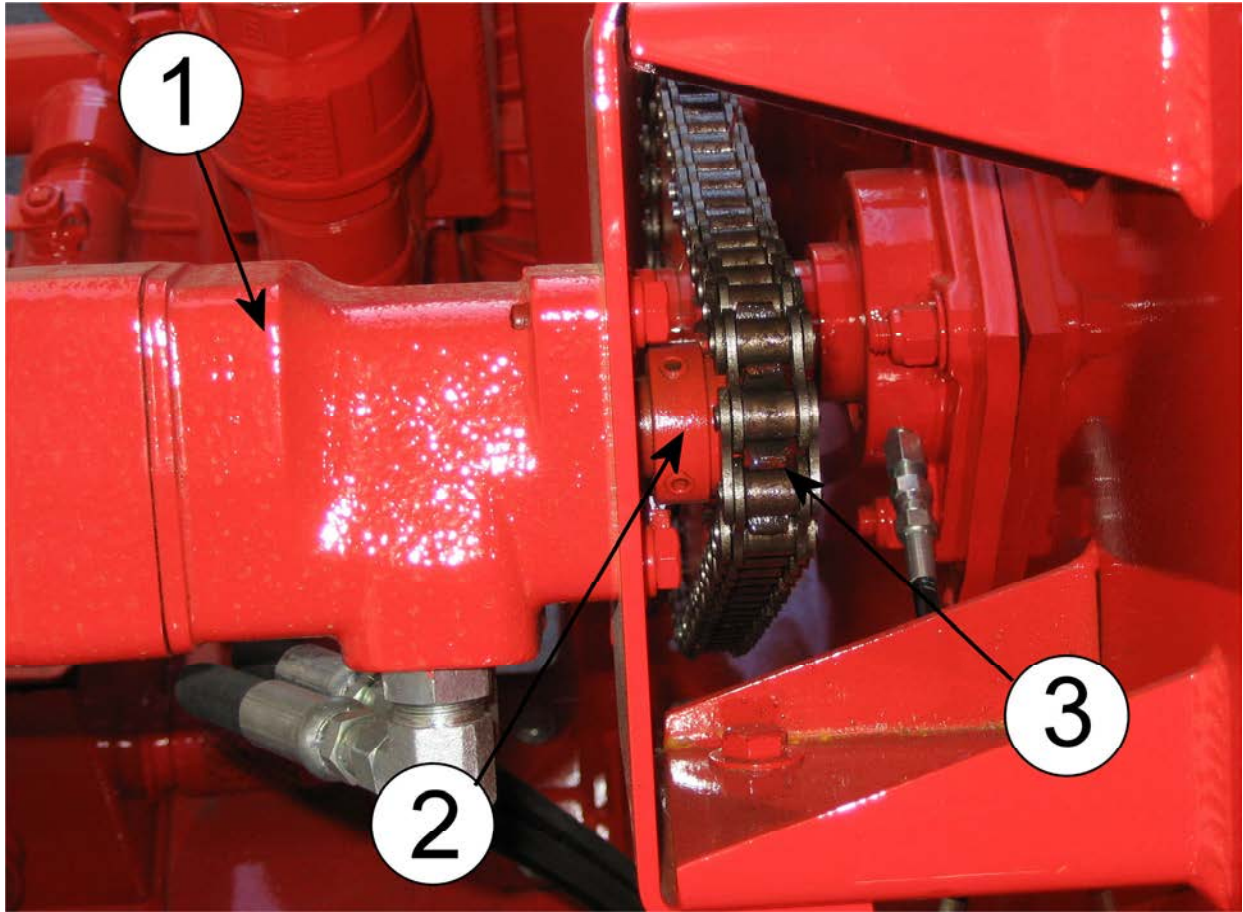

**AGITATOR DRIVE PICTURE 2**

<b>NUMBER</b>	<b>PART NUMBER</b>	<b>DESCRIPTION</b>
<b>1</b>	<b>70236</b>	<b>HYDRAULIC MOTOR</b>
<b>2</b>	<b>70239</b>	<b>NO. 60 - 9 TOOTH SPROCKET</b>
<b>3</b>	<b>70240</b>	<b>NO. 60 ROLLER CHAIN</b>

**CRAFCO SUPER SEALCOATER 550 & 800  
PART LIST**

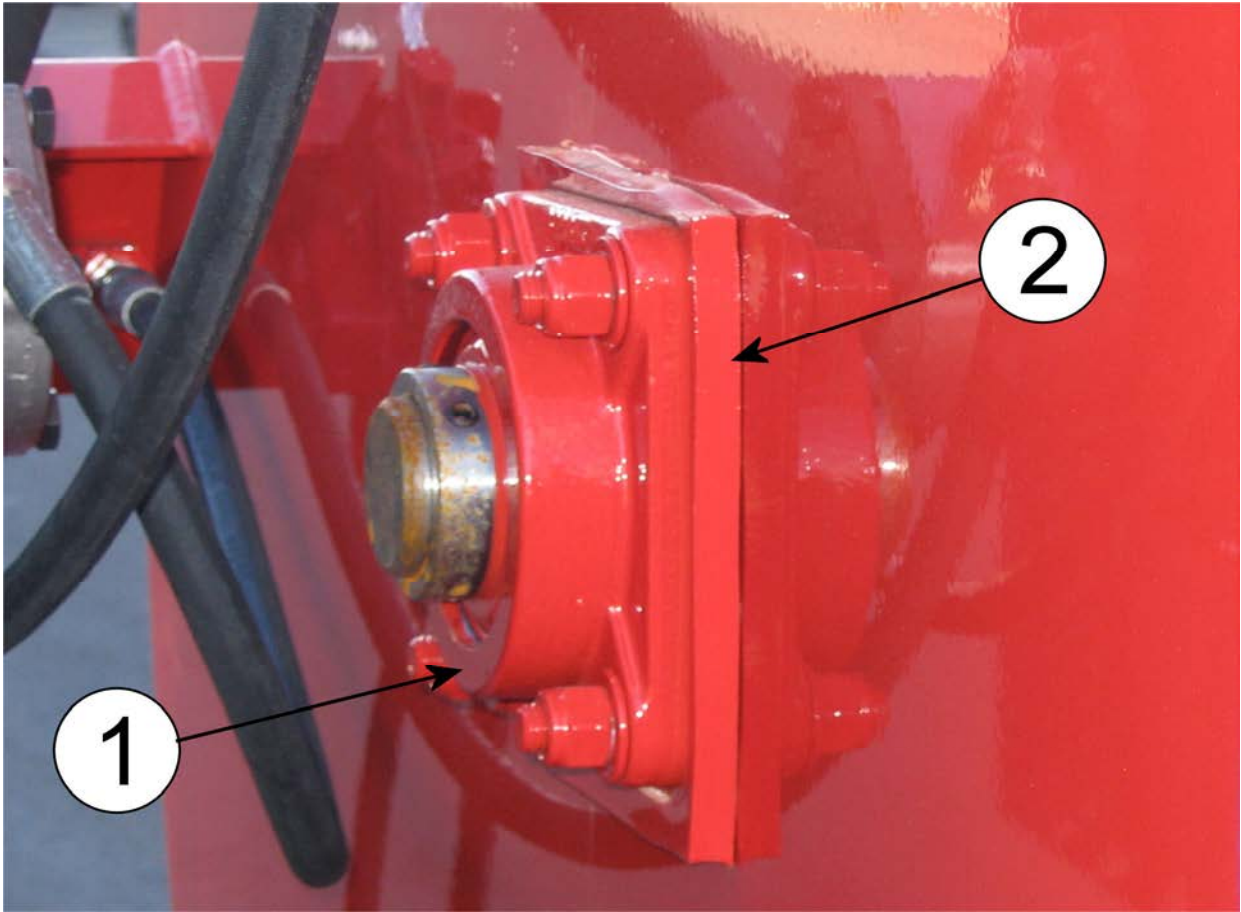

**AGITATOR DRIVE PICTURE 3**

<b>NUMBER</b>	<b>PART NUMBER</b>	<b>DESCRIPTION</b>
<b>1</b>	<b>70237</b>	<b>1 3/4" FLANGE BEARING</b>
<b>2</b>	<b>70234</b>	<b>AGITATOR BEARING GASKET</b>

**CRAFCO SUPER SEALCOATER 550 & 800  
PART LIST**

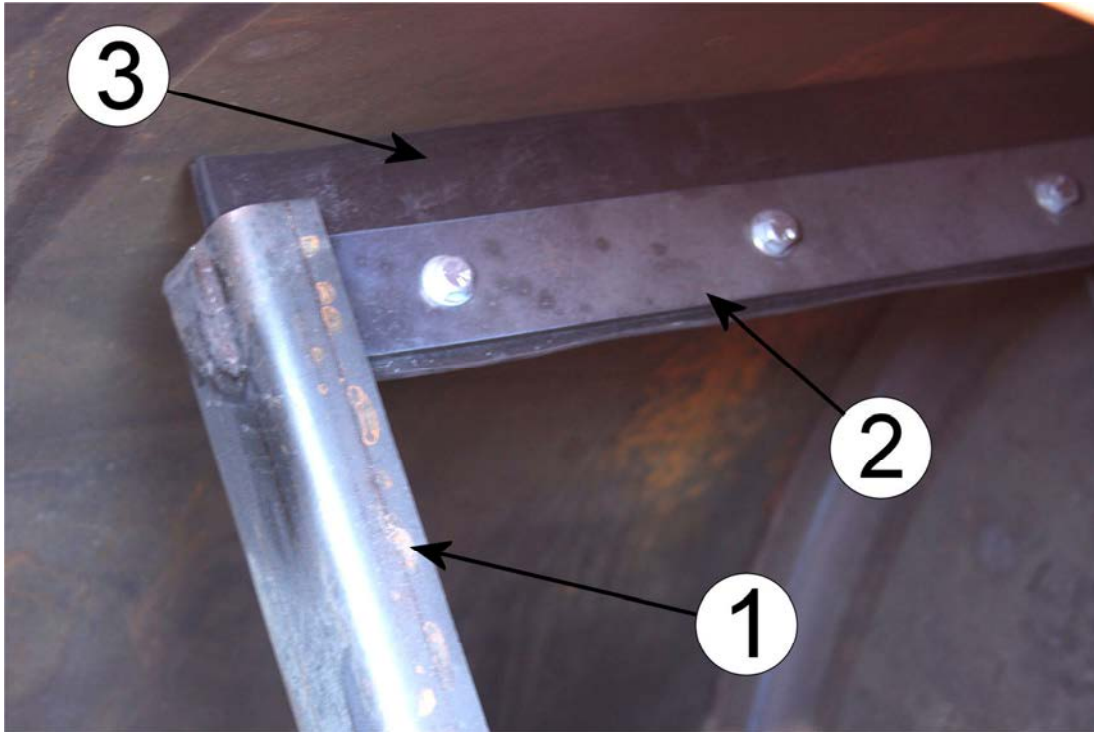

**AGITATOR DRIVE PICTURE 4**

<b>NUMBER</b>	<b>PART NUMBER</b>	<b>DESCRIPTION</b>
<b>1</b>	<b>70179 (550 GAL) 70544 (800 GAL)</b>	<b>550 AGITATOR PADDLE ARM 800 AGITATOR PADDLE ARM</b>
<b>2</b>	<b>70181 70183</b>	<b>AGITATOR CLAMP – OUTSIDE AGITATOR CLAMP - CENTER</b>
<b>3</b>	<b>70184 70185</b>	<b>PADDLE WIPER – OUTSIDE PADDLE WIPER - CENTER</b>

**CRAFCO SUPER SEALCOATER 550 & 800  
PART LIST**

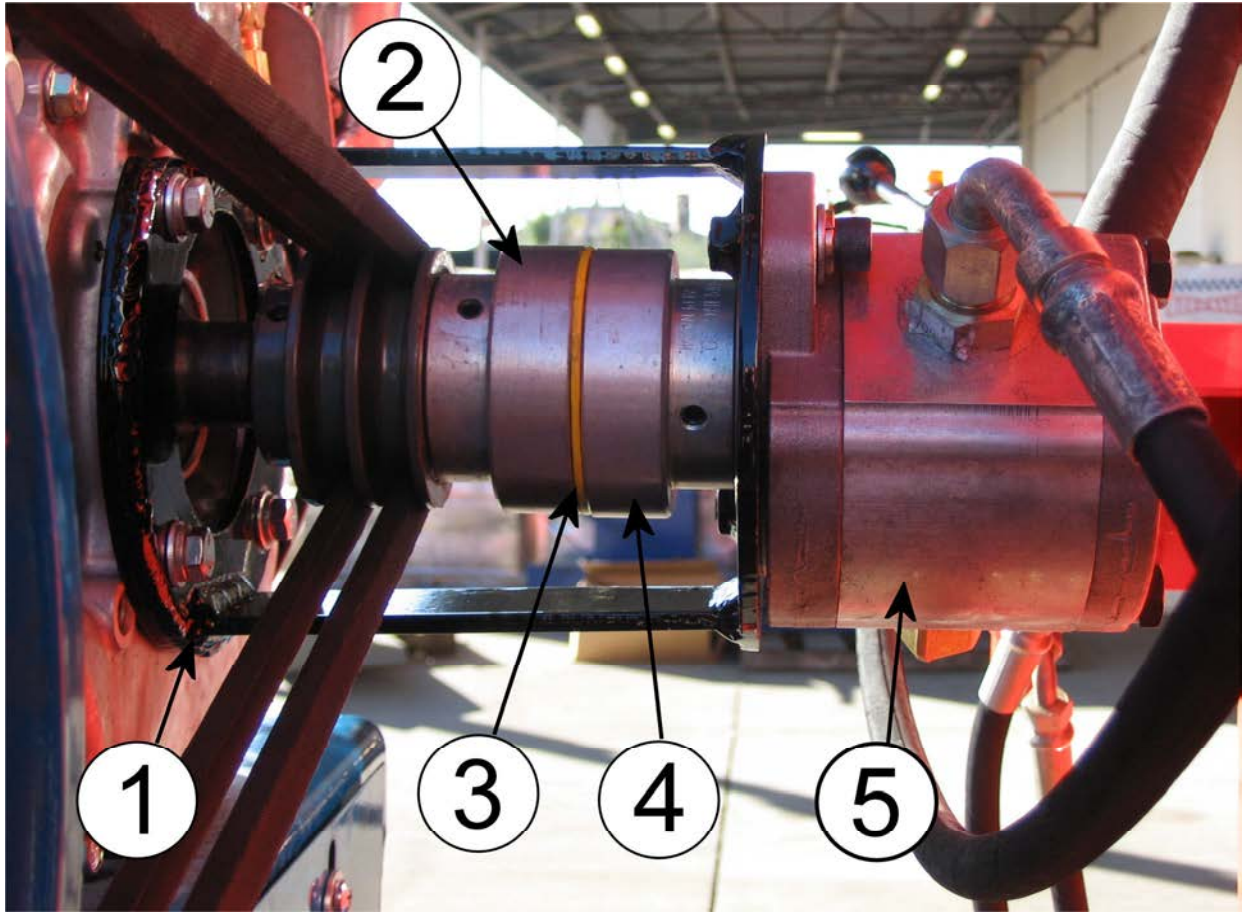

**HYDRAULIC DRIVE PICTURE 1**

<b>NUMBER</b>	<b>PART NUMBER</b>	<b>DESCRIPTION</b>
<b>1</b>	<b>70215</b>	<b>HYDRAULIC PUMP MOUNTING BRACKET</b>
<b>2</b>	<b>44829</b>	<b>COUPLING HALF, 1"</b>
<b>3</b>	<b>44830</b>	<b>SPIDER COUPLING</b>
<b>4</b>	<b>56303</b>	<b>COUPLING HALF, 5/8"</b>
<b>5</b>	<b>70220</b>	<b>HYDRAULIC PUMP</b>



**CRAFCO SUPER SEALCOATER 550 & 800  
PART LIST**

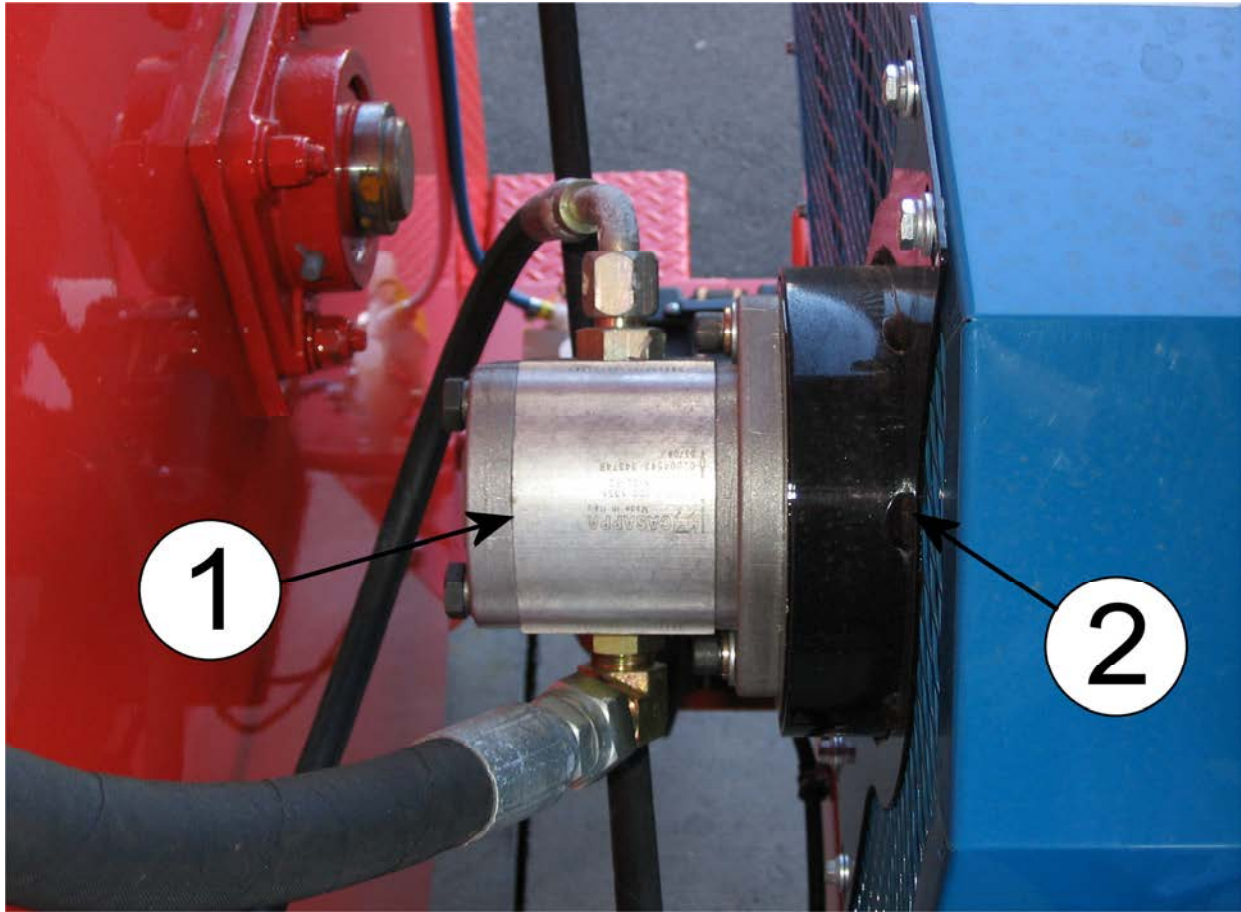

**HYDRAULIC DRIVE PICTURE 2**

<b>NUMBER</b>	<b>PART NUMBER</b>	<b>DESCRIPTION</b>
<b>1</b>	<b>70220</b>	<b>HYDRAULIC PUMP</b>
<b>2</b>	<b>70262</b>	<b>HYDRAULIC PUMP GUARD</b>

**CRAFCO SUPER SEALCOATER 550 & 800  
MATERIAL SYSTEM PART LIST**

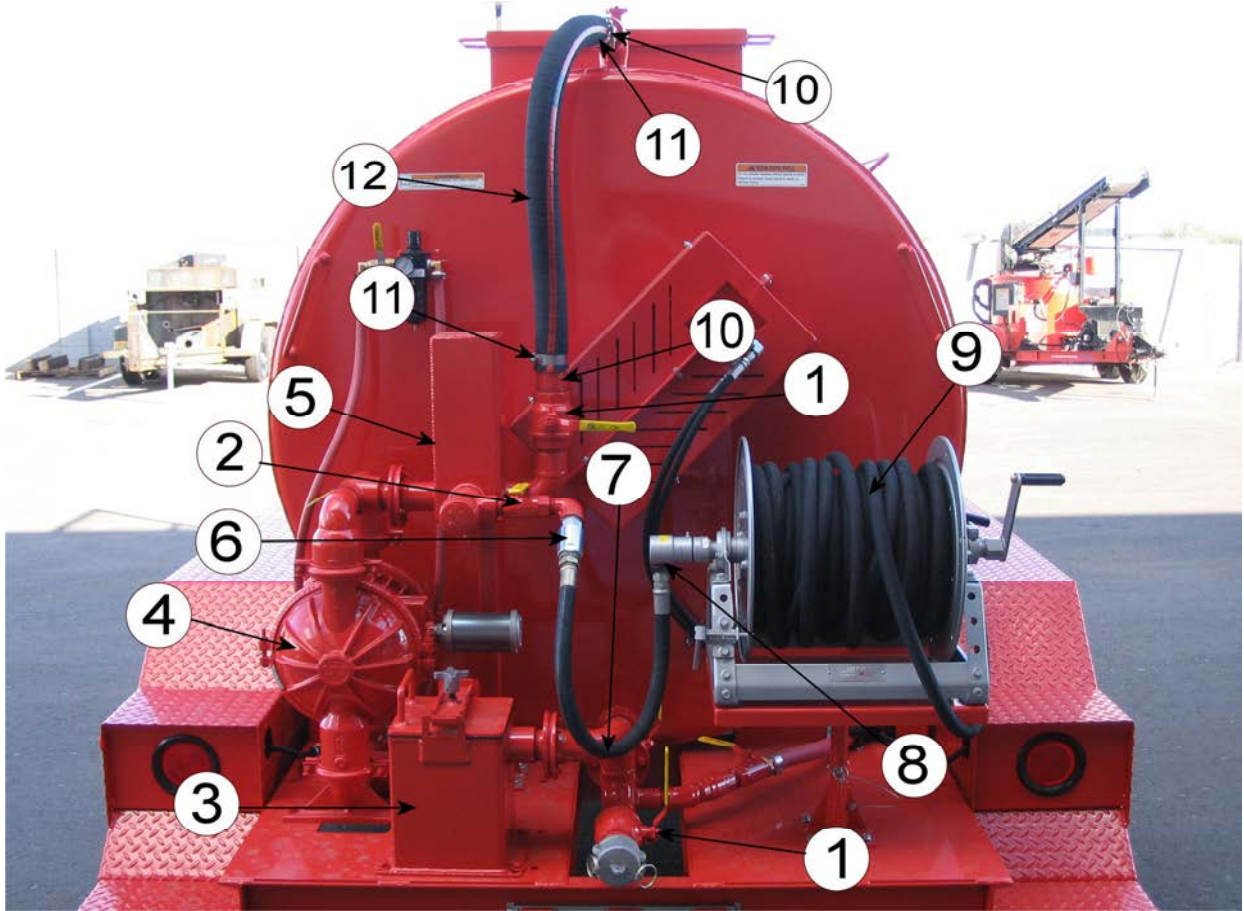

**MATERIAL SYSTEM PICTURE 1**

NUMBER	PART NUMBER	DESCRIPTION
1	29281	2" BALL VALVE
2	29236	1" BALL VALVE
3	70110	STRAINER BOX ASSEMBLY
4	70167	2" AIR DIAPHRAGM PUMP
5	70125	EXPANSION TANK ASSEMBLY
6	27048	1" INLINE SWIVEL
7	70301	HOSE ASSEMBLY
8	28351	1" X 3/4" HEX HEAD BUSHING
9	70302	3/4" X 100' SLURRY HOSE
10	70303	2" BARB FITTING
11	70304	2" HOSE CLAMP
12	70305	2" HOSE

**CRAFCO SUPER SEALCOATER 550 & 800  
OPTIONAL WATER SYSTEM PART LIST**

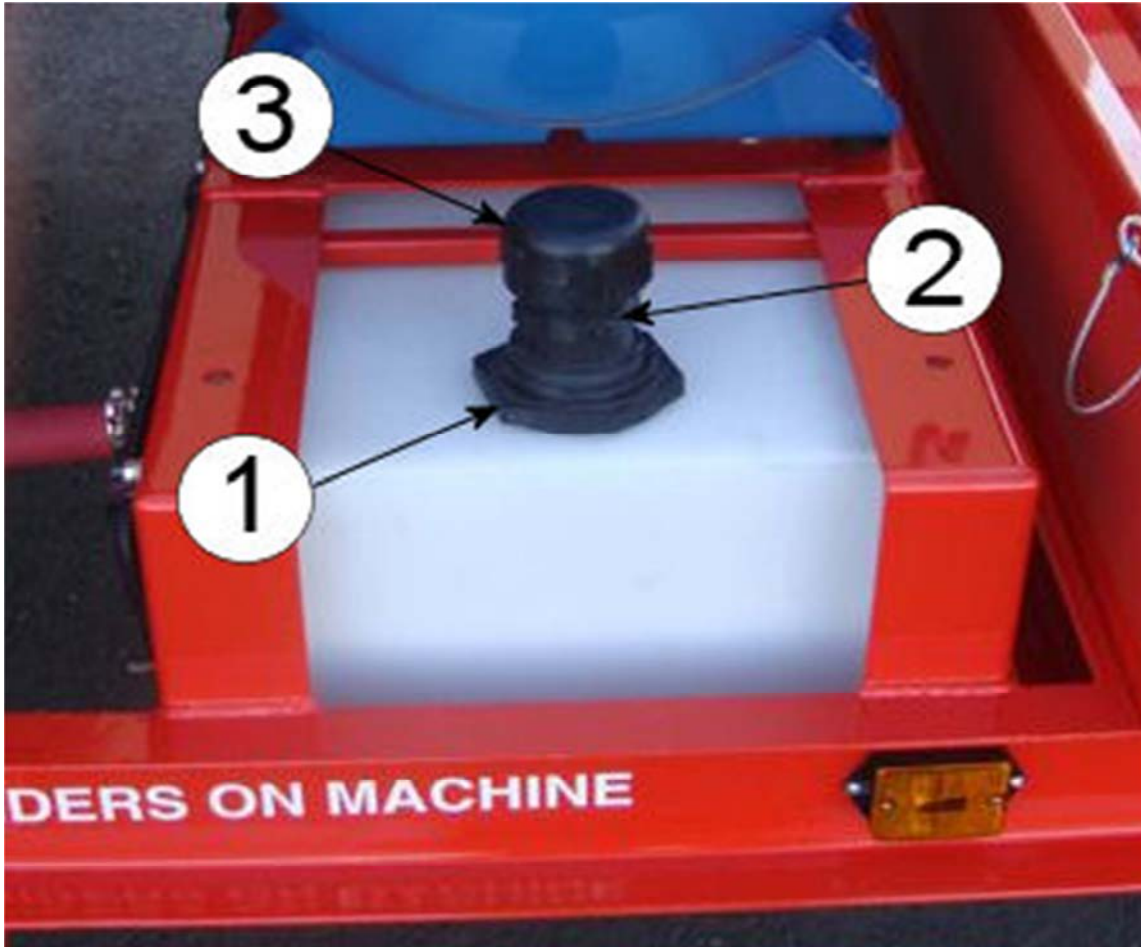

**OPTIONAL WATER SYSTEM PICTURE 1**

<b>NUMBER</b>	<b>PART NUMBER</b>	<b>DESCRIPTION</b>
<b>1</b>	<b>70163</b>	<b>2" BULKHEAD FITTING</b>
<b>2</b>	<b>70166</b>	<b>2" SCH. 40 X 2 ½" LONG PLASTIC PIPE NIPPLE</b>
<b>3</b>	<b>70164</b>	<b>2" SCH. 80 PLASTIC PIPE CAP</b>

**CRAFCO SUPER SEALCOATER 550 & 800  
OPTIONAL WATER SYSTEM PART LIST**

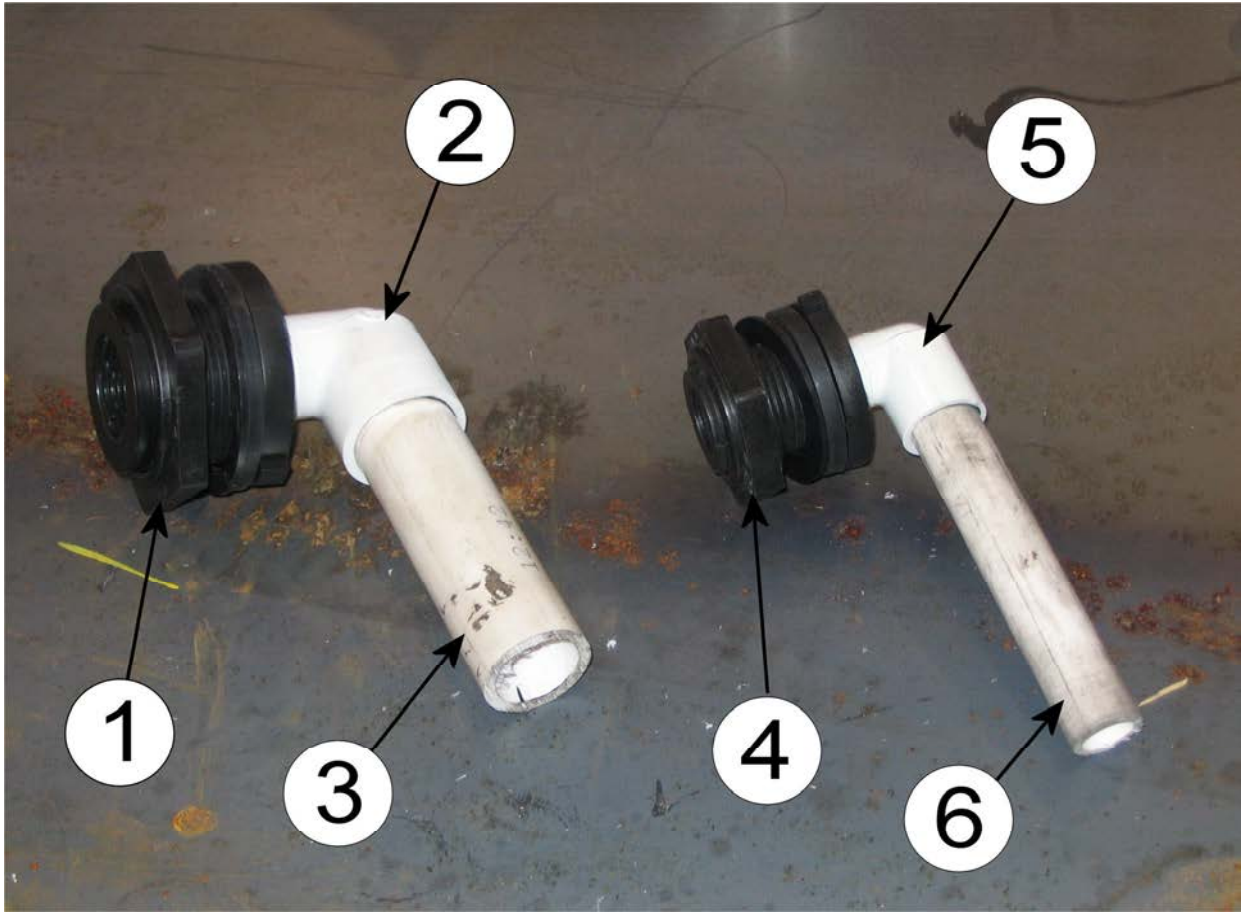

**OPTIONAL WATER SYSTEM PICTURE 2 – SUCTION TUBES**

<b>NUMBER</b>	<b>PART NUMBER</b>	<b>DESCRIPTION</b>
1	70162	1" PLASTIC BULKHEAD FITTING
2	70284	1" 90° PVC STREET ELBOW
3	70282	1" SCH. 40 PVC PIPE X 6.5" LONG
4	70161	1/2" PLASTIC BULKHEAD FITTING
5	70285	1/2" 90° PVC STREET ELBOW
6	70283	1/2" SCH. 40 PVC PIPE X 6.5" LONG

**CRAFCO SUPER SEALCOATER 550 & 800  
OPTIONAL WATER SYSTEM PART LIST**

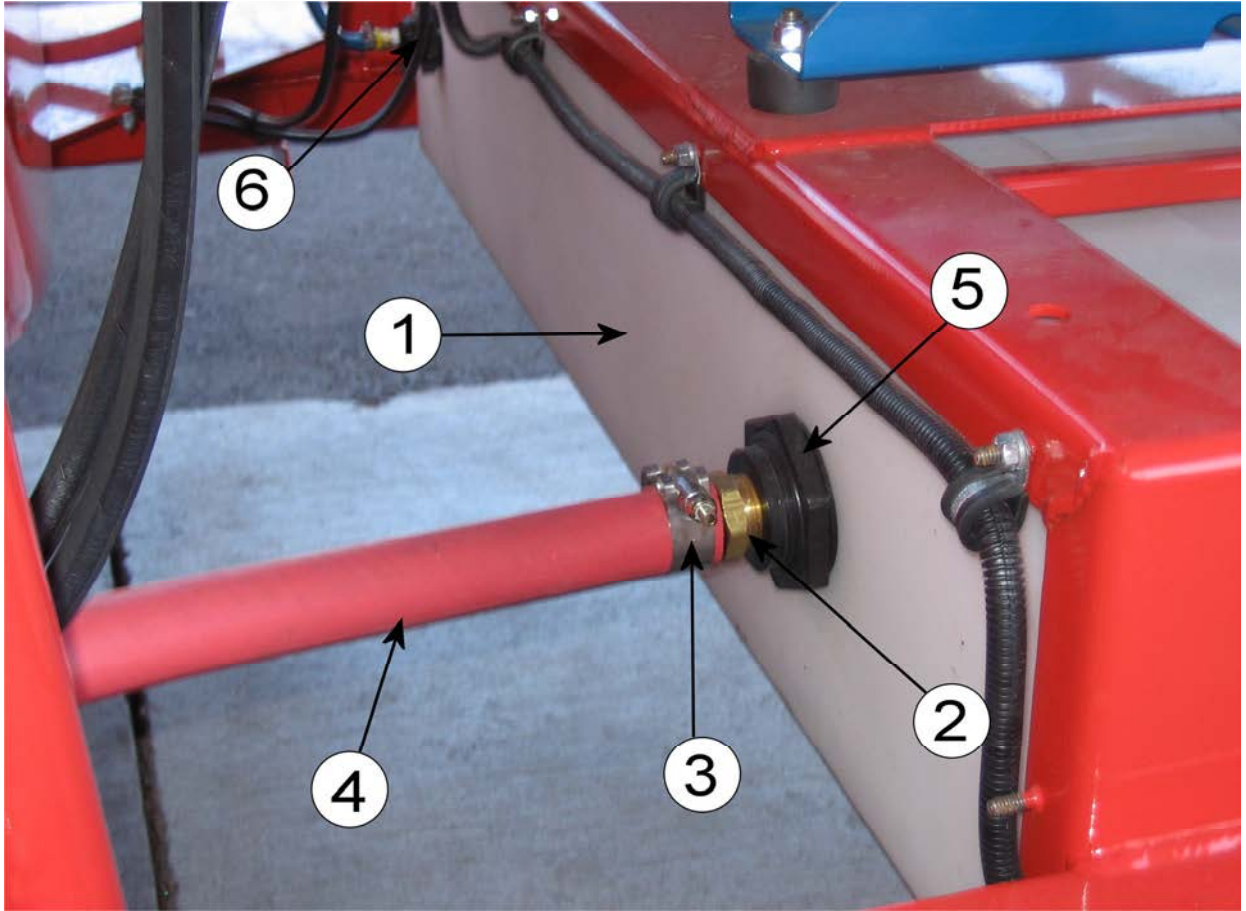

**OPTIONAL WATER SYSTEM PICTURE 3**

<b>NUMBER</b>	<b>PART NUMBER</b>	<b>DESCRIPTION</b>
<b>1</b>	<b>70151</b>	<b>35 GAL PLASTIC WATER TANK</b>
<b>2</b>	<b>70289</b>	<b>1" HOSE STRAIGHT MALE PUSH-ON FITTING</b>
<b>3</b>	<b>70290</b>	<b>T-BOLT CLAMP – 1 1/2</b>
<b>4</b>	<b>70291</b>	<b>1" PUSH-ON BLUE HOSE</b>
<b>5</b>	<b>70162</b>	<b>1" PLASTIC BULKHEAD FITTING</b>
<b>6</b>	<b>70161</b>	<b>½" PLASTIC BULKHEAD FITTING</b>

**CRAFCO SUPER SEALCOATER 550 & 800  
OPTIONAL WATER SYSTEM PART LIST**

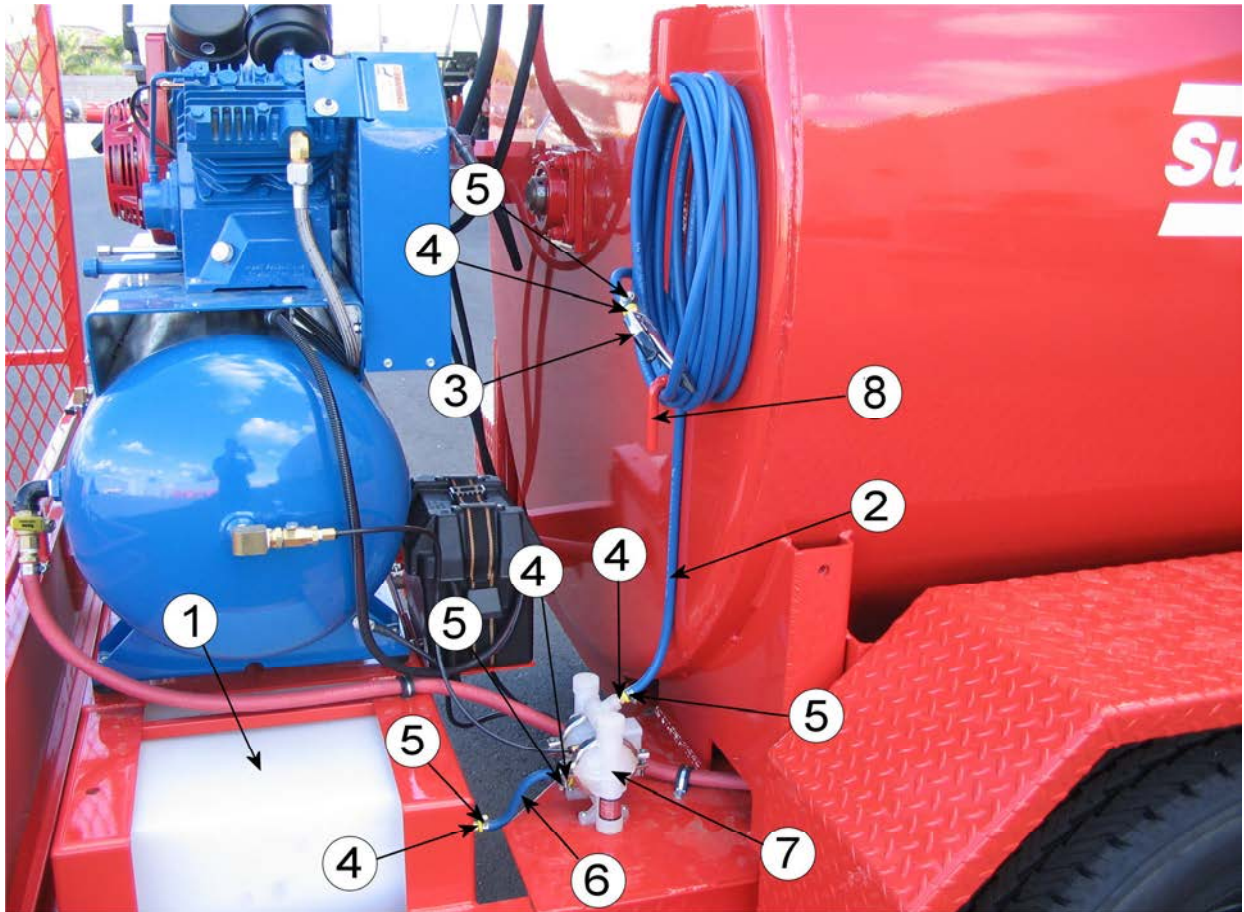

**OPTIONAL WATER SYSTEM PICTURE 4**

<b>NUMBER</b>	<b>PART NUMBER</b>	<b>DESCRIPTION</b>
<b>1</b>	<b>70151</b>	<b>35 GAL PLASTIC WATER TANK</b>
<b>2</b>	<b>70287</b>	<b>¼" PUSH-ON BLUE HOSE X 25'</b>
<b>3</b>	<b>70288</b>	<b>RUBBER TIP BLOW GUN</b>
<b>4</b>	<b>26751</b>	<b>¼" HOSE STRAIGHT MALE PUSH-ON FITTING</b>
<b>5</b>	<b>26080</b>	<b>GEAR CLAMP SIZE #4</b>
<b>6</b>	<b>70286</b>	<b>¼" PUSH-ON BLUE HOSE X 1'</b>
<b>7</b>	<b>70173</b>	<b>0.25 AIR DIAPHRAGM PUMP</b>
<b>8</b>	<b>91281</b>	<b>HOSE STROAGE BRACKET</b>

**CRAFCO SUPER SEALCOATER 550 & 800  
OPTIONAL WATER SYSTEM PART LIST**

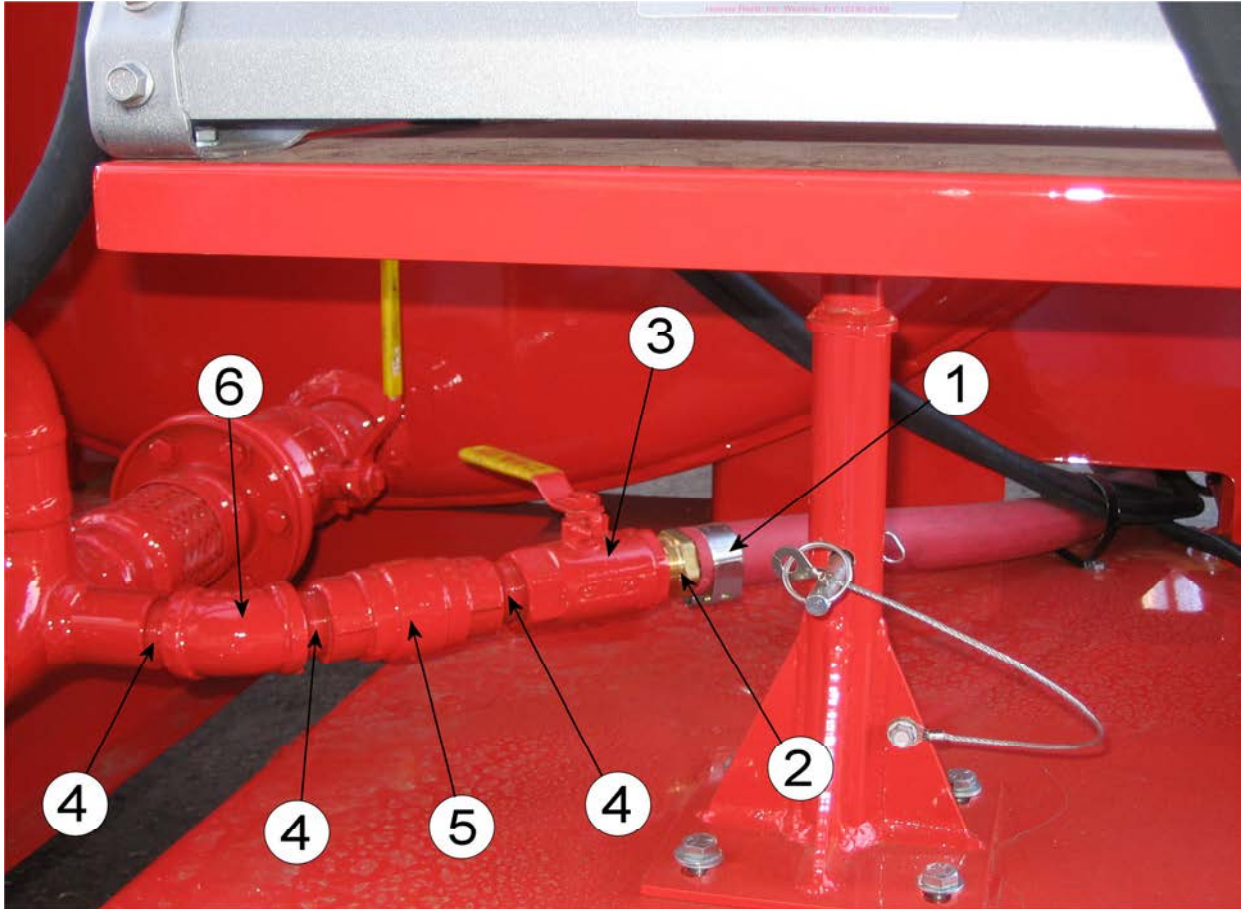

**OPTIONAL WATER SYSTEM PICTURE 5**

<b>NUMBER</b>	<b>PART NUMBER</b>	<b>DESCRIPTION</b>
<b>1</b>	<b>70290</b>	<b>T-BOLT CLAMP, 1 1/2</b>
<b>2</b>	<b>70289</b>	<b>1" HOSE STRAIGHT MALE PUSH- ON FITTING</b>
<b>3</b>	<b>29236</b>	<b>1" BRONZE BALL VALVE</b>
<b>4</b>	<b>28005</b>	<b>1" CLOSE NIPPLE</b>
<b>5</b>	<b>70254</b>	<b>1" BRASS CHECK VALVE</b>
<b>6</b>	<b>28195</b>	<b>1" 45° ELBOW</b>

**CRAFCO SUPER SEALCOATER 550 & 800**  
**AIR SYSTEM PART LIST**

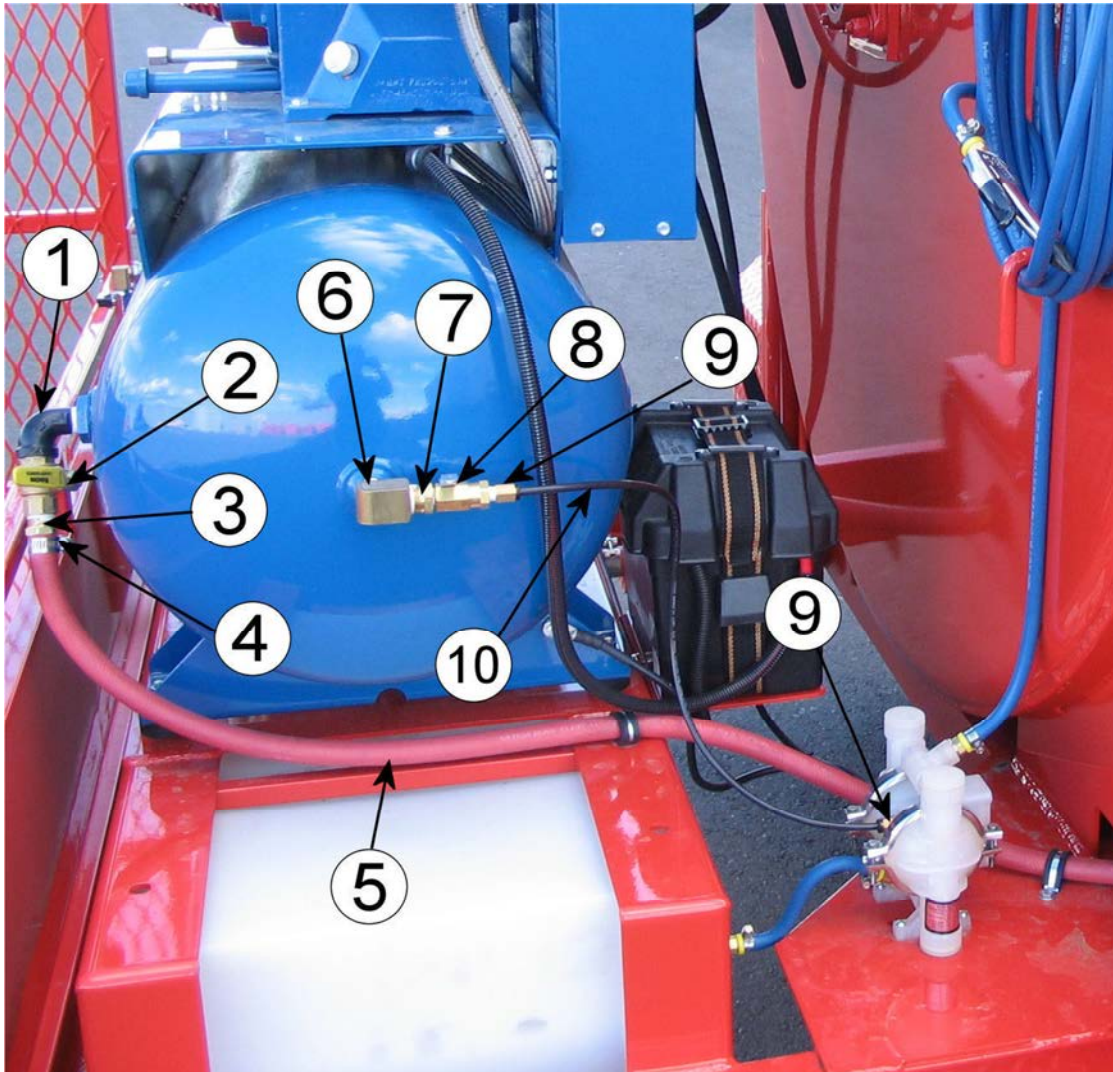

**AIR SYSTEM PICTURE 1**

NUMBER	PART NUMBER	DESCRIPTION
1	28238	½" STREET ELBOW
2	29214	½" BALL VALVE
3	70292	BARB, ½ X ½ MPT
4	70293	CLAMP, ½ X 29/32
5	70294	HOSE, DUROFLEX ½ 300PS X 154" LONG
6	70297	STREET 90, ½ BRASS (OPTIONAL)
7	70321	½ X 1/8 HEX HEAD PIPE BUSHING (OPTIONAL)
8	70298	BALL VALVE, 1/8 M X FPT (OPTIONAL)
9	70299	AB FITTING, ¼ X 1/8 MPT (OPTIONAL)
10	90897	TUBING, ¼ NYLON AB X 2' LONG (OPTIONAL)



**CRAFCO SUPER SEALCOATER 550 & 800  
AIR SYSTEM PART LIST**

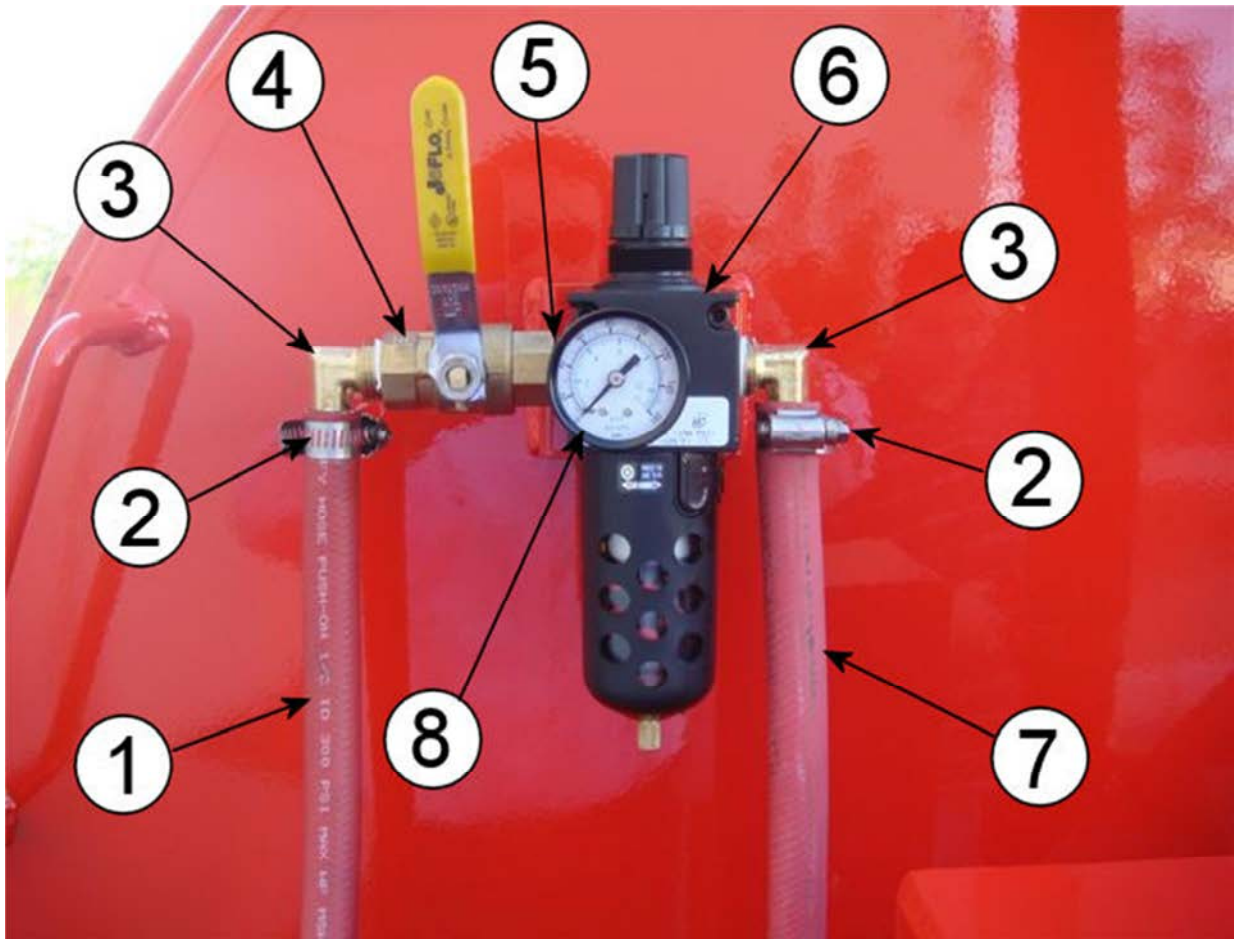

**AIR SYSTEM PICTURE 2**

<b>NUMBER</b>	<b>PART NUMBER</b>	<b>DESCRIPTION</b>
<b>1</b>	<b>70296</b>	<b>HOSE DUROFLEX ½ 300PS X 30" LONG</b>
<b>2</b>	<b>70293</b>	<b>CLAMP, ½ X 29/32</b>
<b>3</b>	<b>70292</b>	<b>BARB, ½ X ½ MPT 90 FITTING</b>
<b>4</b>	<b>29214</b>	<b>½" BALL VALVE</b>
<b>5</b>	<b>28003</b>	<b>½" CLOSE NIPPLE</b>
<b>6</b>	<b>70241</b>	<b>½" AIR REGULATOR &amp; FILTER</b>
<b>7</b>	<b>70294</b>	<b>HOSE DUROFLEX ½ 300PS X 154" LONG</b>
<b>8</b>	<b>70242</b>	<b>½" AIR PRESSURE GAUGE</b>

**CRAFCO SUPER SEALCOATER 550 & 800  
AIR SYSTEM PART LIST**

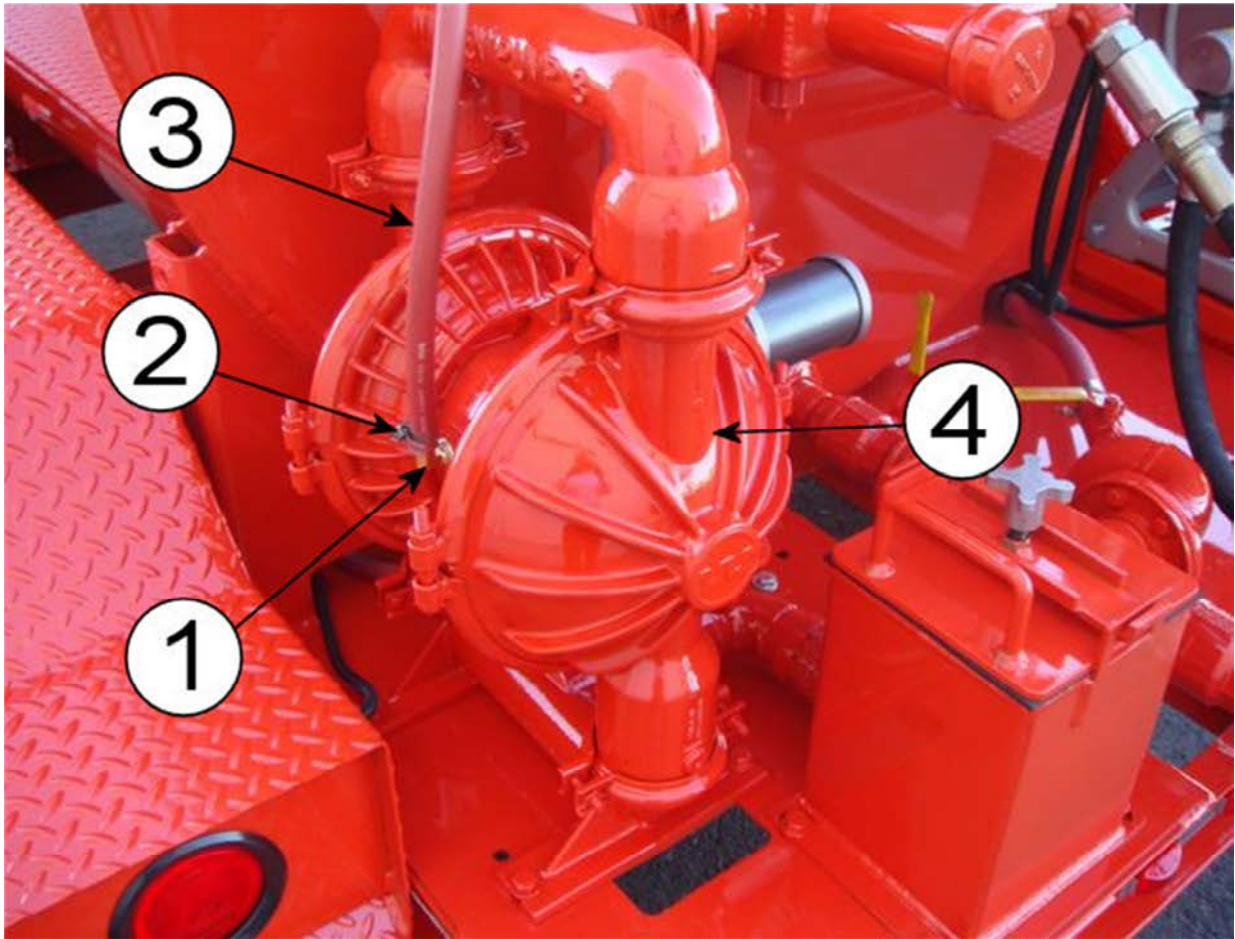

**AIR SYSTEM PICTURE 3**

<b>NUMBER</b>	<b>PART NUMBER</b>	<b>DESCRIPTION</b>
<b>1</b>	<b>70295</b>	<b>BARB, ½ X ½ MPT 90° FITTING</b>
<b>2</b>	<b>70293</b>	<b>CLAMP, ½ X 29/32</b>
<b>3</b>	<b>70296</b>	<b>HOSE DUROFLEX ½ 300PS X 30" LONG</b>
<b>4</b>	<b>70167</b>	<b>2" AIR DIAPHRAGM PUMP</b>

**CRAFCO SUPER SEALCOATER 550 & 800  
HYDRAULIC SYSTEM PART LIST**

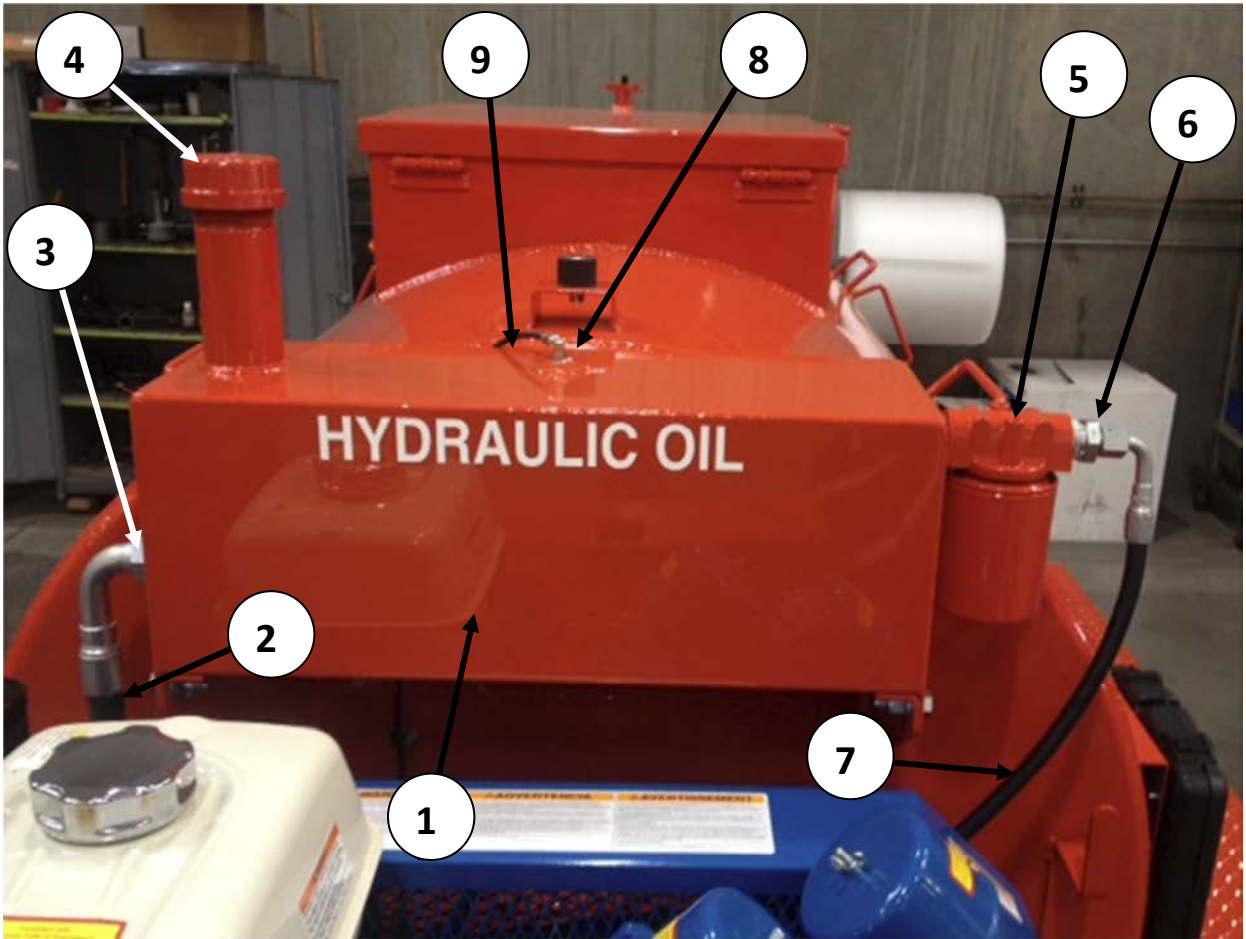

**HYDRAULIC SYSTEM PICTURE 1**

NUMBER	PART NUMBER	DESCRIPTION
1	70100	HYDRAULIC OIL TANK ASSEMBLY
2	C12-16FJ9-12FJ-17 (550 GAL) C12-16FJ9-12FJ-24 (800 GAL)	HYDRAULIC HOSE ASSEMBLY (TANK TO PUMP)
3	29818	SAE O-RING 1 ¼" X 1" JIC ADAPTER
4	28273	CAP, 2" PIPE
5	22070	HYD. FILTER W/ MOUNTING BASE
6	40317	1" NPT X ½" JIC FITTING
7	AX6-8FJ9-6FJ-54 (550 GAL) AX6-8FJ9-6FJ-60 (800 GAL)	HYDRAULIC HOSE ASSEMBLY (VALVE TO TANK)
8	60233	¼" 90 PLASTIC TUBE FITTING
9	70106	HYD. OIL BREATHER TUBE

**CRAFCO SUPER SEALCOATER 550 & 800  
HYDRAULIC SYSTEM PART LIST**

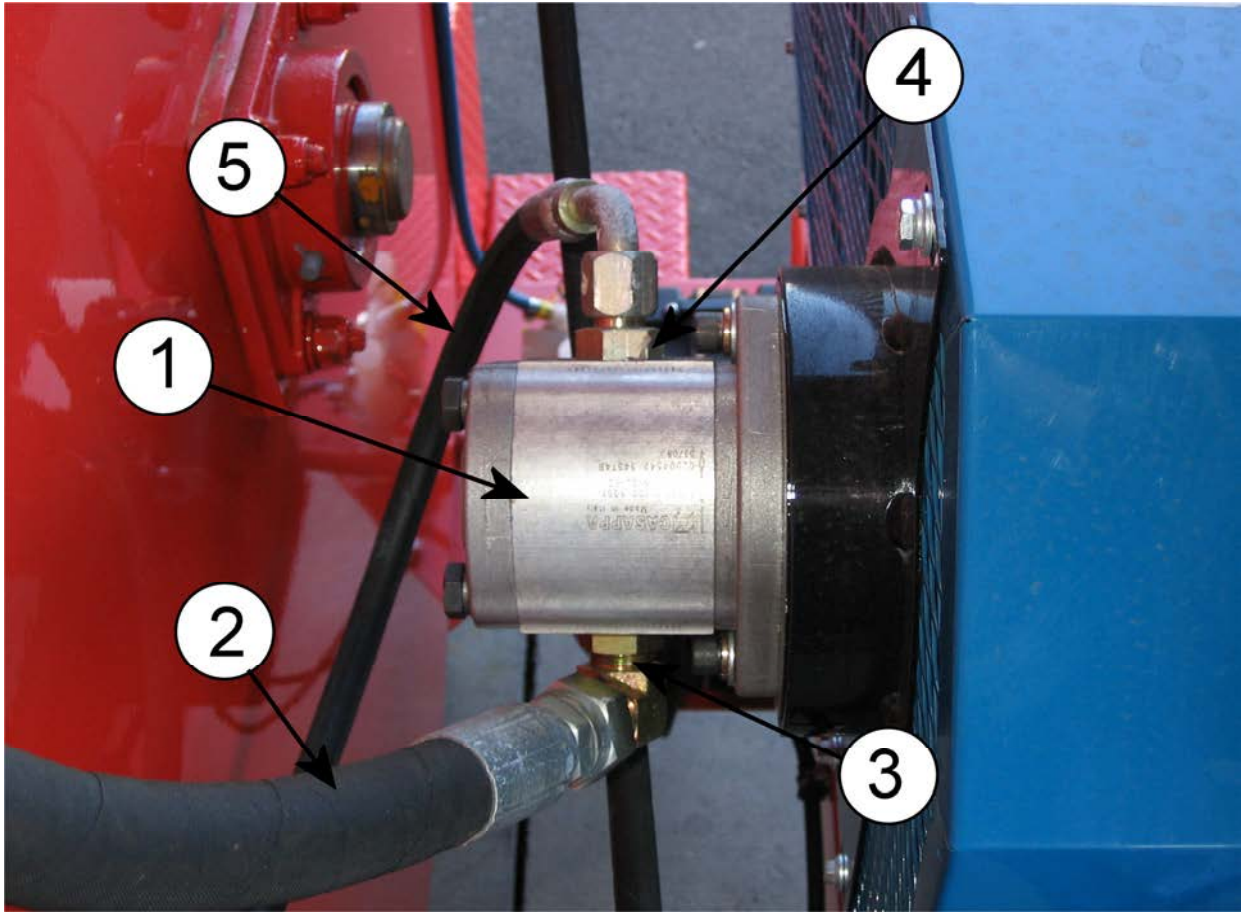

**HYDRAULIC SYSTEM PICTURE 2**

<b>NUMBER</b>	<b>PART NUMBER</b>	<b>DESCRIPTION</b>
1	70220	HYDRAULIC PUMP
2	C12-16FJ9-12FJ-17 (550 GAL) C12-16FJ9-12FJ-24 (800 GAL)	HYDRAULIC HOSE ASSEMBLY (TANK TO PUMP)
3	29934	¾" JIC TUBE X 5/8" O-RING ADAPTER
4	29913	5/8" O-RING X ½" JIC ADAPTER
5	AX6-8FJ9-6FJ-19 (550 GAL) AX6-8FJ9-6FJ-32 (800 GAL)	HYDRAULIC HOSE ASSEMBLY (PUMP TO VALVE)

**CRAFCO SUPER SEALCOATER 550 & 800  
HYDRAULIC SYSTEM PART LIST**

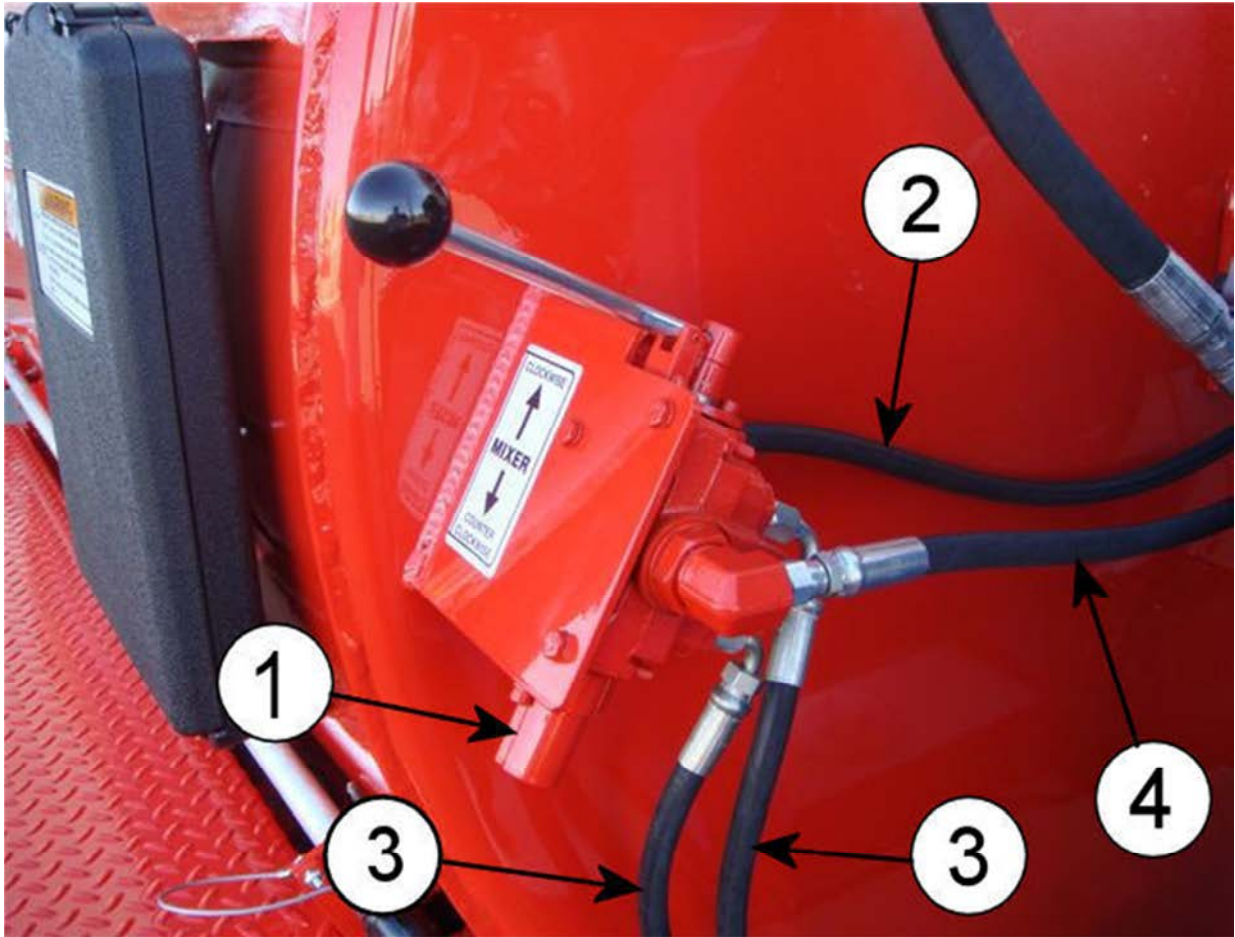

**HYDRAULIC SYSTEM PICTURE 3**

<b>NUMBER</b>	<b>PART NUMBER</b>	<b>DESCRIPTION</b>
<b>1</b>	<b>41093</b>	<b>HYDRAULIC VALVE</b>
<b>2</b>	<b>AX6-8FJ9-6FJ-19 (550 GAL)</b> <b>AX6-8FJ9-6FJ-32 (800 GAL)</b>	<b>HYDRAULIC HOSE ASSEMBLY (PUMP TO VALVE)</b>
<b>3</b>	<b>AX6-6FJ-6FJ9-143 (550 GAL)</b> <b>AX6-6FJ-6FJ9-146 (800 GAL)</b>	<b>HYDRAULIC HOSE ASSEMBLY (VALVE TO MOTOR)</b>
<b>4</b>	<b>AX6-8FJ9-6FJ-54 (550 GAL)</b> <b>AX6-8FJ9-6FJ-60 (800 GAL)</b>	<b>HYDRAULIC HOSE ASSEMBLY (VALVE TO TANK)</b>

**CRAFCO SUPER SEALCOATER 550 & 800  
HYDRAULIC SYSTEM PART LIST**

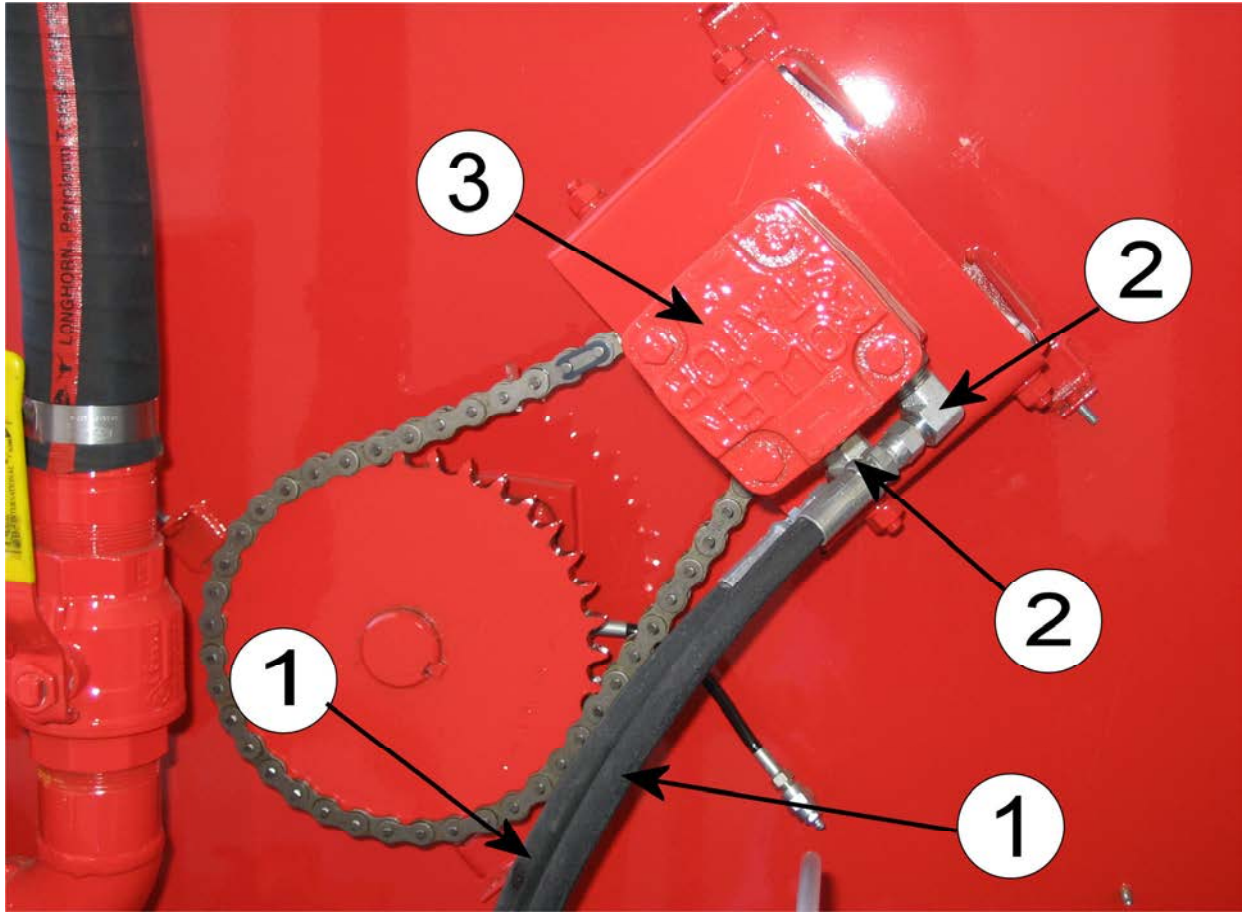

**HYDRAULIC SYSTEM PICTURE 4**

<b>NUMBER</b>	<b>PART NUMBER</b>	<b>DESCRIPTION</b>
<b>1</b>	<b>AX6-6FJ-6FJ9-143 (550 GAL) AX6-6FJ-6FJ9-146 (800 GAL)</b>	<b>HYDRAULIC HOSE ASSEMBLY (VALVE TO MOTOR)</b>
<b>2</b>	<b>29828</b>	<b>90 BOSS ADAPTER</b>
<b>3</b>	<b>70236</b>	<b>HYDRAULIC MOTOR</b>





©2014 CrafcO, Inc.